



PT3 LED Pole Top

HIGHLIGHTS

- Pole top luminaires with a modern twist from everyday pathway fixtures
- Controls Ready makes adding controls quick and easy. Includes screw-in receptacle for 3-pin twist-lock NEMA photocell receptacle with shorting cap included
- PowerSet feature allows for multiple lumen stops out of the box
- FieldCCeT features provides multiple color temperature settings in one fixture

CERTIFICATIONS

- UL listed for US & Canada
- RoHS Compliant
- FCC Compliant
- ICES-005 Compliant
- IP65 Rated
- DesignLights Consortium® Premium Qualified - meets the requirements for the highest DLC qualification for efficacy and lumen maintenance

PERFORMANCE

- High Efficacy, up to 147 lm/W
- Available in PowerSet models: power-selectable 55/40/25W, 100/80/60W, 150/125/100W
- Available in FieldCCeT models: field-selectable 30/40/5000K
- CRI: >80
- Estimated L70: 100,000 Hours

ELECTRICAL

- Input voltage: 120-347V
- 0-10V dimming, dim-to-off
- Surge Protection: 6kV included
- Power factor: >0.9
- THD: <20%

THERMAL

- -40°F to 122°F (-40°C to 50°C) ambient operating temperature (55 & 100W)
- -40°F to 113°F (-40°C to 45°C) ambient operating temperature (150W)

CONSTRUCTION

- Matte black die-cast aluminum housing
- Glass protective lens (55 & 100W); Polycarbonate lens (150W)

WARRANTY

- 5-Year limited warranty available [online](#). Contact your EiKO sales rep for additional details.

project name	type
catalog number	voltage
approved by	date



APPLICATIONS

- Parking Areas
- Roadways
- Campuses
- Streetscapes
- Parks
- Area security lighting

KEY FEATURES

INSTALLATION

Pole top arms come pre-installed to the fixture head and fixture base. The max. pole/tenon diameter is 3"; the min. pole/tenon diameter is 1-3/4", and the max. depth of adapter is 3-3/8". Install screws are provided.

PHOTOCELL

Integrated NEMA 3-pin receptacle and shorting cap included. NEMA 3-pin photocell accessories available for enhanced security and additional energy savings.

MODERN APPEARANCE WITH PERFORMANCE

Matte black finish; glass protective lens (55 & 100W); polycarbonate lens (150W). FieldCCeT and PowerSet allows for wattage and CCT selectability.



**FITS POLE/TENON DIAMETER: MAX 3"
MIN: 1-3/4". MAX DEPTH OF ADAPTER:
3-3/8". INSTALL SCREWS PROVIDED**

**MATTE BLACK FINISH
GLASS LENS (55 & 100W)
POLYCARBONATE LENS (150W)
POWERSET AND FIELDCCET**



**3-PIN TWIST-LOCK NEMA
PHOTOCELL RECEPTACLE
WITH SHORTING CAP
INCLUDED**

AVAILABLE MODELS

ORDER	ORDER CODE	ITEM #	WATTS*	CCT**	LUMENS	EFFICACY (lm/W)	VOLTAGE	TRADITIONAL WATTAGE EQUIVALENT	DLC ID #
									PREMIUM
	14762	PT3-55GS-3	55/40/25W	3000/4000/5000K	7778/5834/3818 lm	145 lm/W	120-347V	Up to 250W HID	PLPOG37YKJJK
	13123	PT3-100GS-3	100/80/60W	3000/4000/5000K	12,698/10,460/8124 lm	130 lm/W	120-347V	up to 320W HID	PL3R4W55UKFS
	13124	PT3-150GS-3	150/125/100W	3000/4000/5000K	20,602/18,285/13,083 lm	140 lm/W	120-347V	up to 400W HID	PLSRE2DCL8U2

* All power-selectable fixtures ship at the highest wattage setting

** All CCT-selectable fixtures ship at 5000K

MODEL CONFIGURATOR					
MODEL	-	WATTS	CCT	-	VOLTAGE
PT3	-			-	

EXAMPLE PART NUMBER: PART NUMBER FROM AVAILABLE MODELS

REFER TO FOLLOWING SECTIONS FOR DETAILS ON AVAILABLE FIELD INSTALLED OPTIONS

PHOTOCELL ACCESSORIES: FIELD INSTALLED

ORDER	ORDER CODE	ITEM #	DESCRIPTION
PHOTOCELL VIA PRE-INSTALLED NEMA 3-PIN RECEPTACLE			
	10041	ELC4536	3-pin NEMA Twist-lock Photocell ELC4536, 120-277V, 2A, 6-year Warranty
	10042	EK4536	3-pin NEMA Twist-lock Premium Photocell EK4536, 120-277V, 6A, 8-year Warranty
	10204	LED4537SC	3-pin NEMA Twist-lock Premium Photocell LED4537SC, 347-480V, 2A, 12-year Warranty
	801334	JL-205C	3-pin NEMA Twist-lock Photocell, 120-277V, 5A and 120W+ only, 2-year Warranty
	801335	JL-207C	3-pin NEMA Twist-lock Photocell, 120-277V, 5A, 5-year Warranty
	801336	JL-207F	3-pin NEMA Twist-lock Photocell, 120-480V, 5A, 5-year Warranty

PRODUCT DIMENSIONS

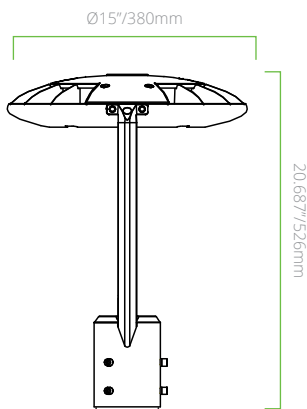

PT3 55/40/25W
Weight: 11.0 lbs / 5.0 kg

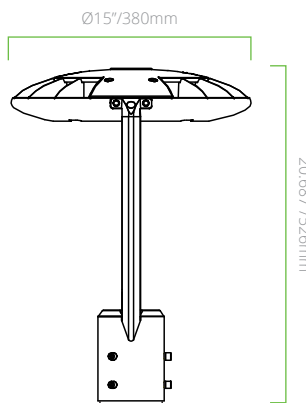

PT3 100/80/60W
Weight: 11.7 lbs / 5.3 kg

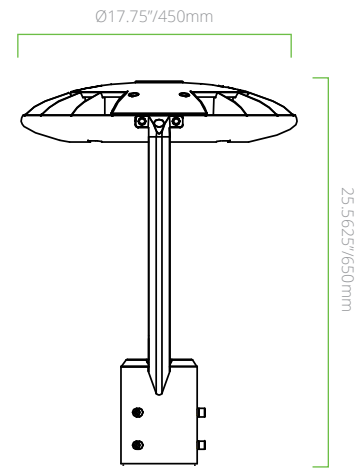

PT3 150/125/100W
Weight: 17.2 lbs / 7.8 kg