



# HID LED HID Replacement

## FEATURES

- LED replacement for high wattage HID fixtures from 50W to 600W
- Universal mounting position
- Lasts 3x longer than metal halide or HPS HID lamps
- FieldCCeT feature allows for multiple “set and forget” CCT options
- Eliminates maintenance costs for over 10 years; no expensive HID lamps or ballasts to replace
- Shatter resistant for reduced risk of injury or breakage
- Integral driver; eliminates the need for external driver or ballast
- Environmentally friendly: contains no glass, mercury, or lead
- Built-in surge protection

## WARRANTY

- 5 year limited warranty. Additional warranty options available. Contact EiKO for details

## APPLICATIONS

- Gyms & Athletic Facilities
- Production Areas
- Shipping/Receiving
- Warehouses
- Exterior Perimeter
- Parking Garage
- Parking Lot

project name	type
catalog number	voltage
approved by	date



SMALL  
STANDARD



MEDIUM  
STANDARD



MEDIUM  
FIELDCCET



LARGE  
STANDARD

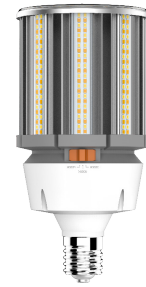

LARGE  
FIELDCCET

<b>PERFORMANCE</b>	Power Consumption	15W, 19W, 24W, 27W, 36W, 45W, 54W, 63W, 80W, 100W, 120W
	Lumens	1,950 - 16,000
	CRI	>80
	Beam	Omnidirectional
	CCT	3000K, 4000K, 5000K, 30/40/5000K FieldCCeT
	Life (L70)	50,000 hours
<b>ELECTRICAL</b>	Power Factor	≥0.9
	Input Voltage	100-277V, 277-480V
<b>CONSTRUCTION</b>	Operating Temperature	Small: -40°F to 140°F (-40°C to 60°C); Medium and FieldCCeT: -40°F to 140°F (-40°C to 60°C); Large: -4°F to 113°F (-20°C to 45°C); Large 277-480V models: -40°F to 113°F (-40°C to 45°C)
	Enclosed Temperature	-4°F to 104°F (-20°C to 40°C)
	Base	E26; EX39
<b>LISTINGS</b>	Certification(s)	DesignLights Consortium® Qualified; cULus Classified; FCC
	Material Usage	RoHS Compliant; no mercury
	Environment	IP64 Rated; Suitable for use in enclosed fixtures



# PERFORMANCE SUMMARY

ORDER CODE	ITEM #	WATT	LUMENS	LPW	CCT	CRI	VOLTS	BASE	LIFE HOURS	REPLACE HID	FCCT	SENSOR READY	DLC STANDARD
<b>SMALL : 15W-24W</b>													
09632	LED15WPT30KMED-G7*	15W	1,875	125	3000K	>80	100-277V	E26	50,000	50W			
09390	LED15WPT40KMED-G7*	15W	1,875	125	4000K	>80	100-277V	E26	50,000	50W			
09391	LED15WPT50KMED-G7*	15W	1,950	130	5000K	>80	100-277V	E26	50,000	50W			
09633	LED19WPT30KMED-G7*	19W	2,375	125	3000K	>80	100-277V	E26	50,000	75W			
09392	LED19WPT40KMED-G7*	19W	2,375	125	4000K	>80	100-277V	E26	50,000	75W			
09393	LED19WPT50KMED-G7*	19W	2,470	130	5000K	>80	100-277V	E26	50,000	75W			
09634	LED24WPT30KMED-G7	24W	3,000	125	3000K	>80	100-277V	E26	50,000	75W			
<b>MEDIUM : 27W-63W</b>													
10228	LED27WPT30KMED-G8	27W	3,650	135	3000K	>80	100-277V	E26	50,000	100W			
10233	LED36WPT30KMED-G8	36W	4,850	135	3000K	>80	100-277V	E26	50,000	150W			
10238	LED36WPT40KMED-G8	36W	5,000	139	4000K	>80	100-277V	E26	50,000	150W			
10240	LED36WPT50KMED-G8	36W	5,200	144	5000K	>80	100-277V	E26	50,000	150W			
12050	LED36WPT40KMED-V-G9	36W	5,400	150	4000K	>80	277-480V	E26	50,000	150W			
12051	LED36WPT50KMED-V-G9	36W	5,400	150	5000K	>80	277-480V	E26	50,000	150W			
10242	LED45WPT30KMED-G8	45W	6,100	136	3000K	>80	100-277V	E26	50,000	175W			
10244	LED45WPT40KMED-G8	45W	6,300	140	4000K	>80	100-277V	E26	50,000	175W			
10246	LED45WPT50KMED-G8	45W	6,500	144	5000K	>80	100-277V	E26	50,000	175W			
10248	LED54WPT30KMED-G8	54W	7,300	135	3000K	>80	100-277V	E26	50,000	200W			
10250	LED54WPT40KMED-G8	54W	7,550	140	4000K	>80	100-277V	E26	50,000	200W			
10252	LED54WPT50KMED-G8	54W	7,800	144	5000K	>80	100-277V	E26	50,000	200W			
10227	LED27WPT30KMOG-G8	27W	3,650	135	3000K	>80	100-277V	EX39	50,000	100W			✓
10230	LED27WPT40KMOG-G8	27W	3,750	138	4000K	>80	100-277V	EX39	50,000	100W			✓
10232	LED27WPT50KMOG-G8	27W	3,900	144	5000K	>80	100-277V	EX39	50,000	100W			✓
10237	LED36WPT30KMOG-G8	36W	4,850	135	3000K	>80	100-277V	EX39	50,000	150W			✓
10239	LED36WPT40KMOG-G8	36W	5,000	139	4000K	>80	100-277V	EX39	50,000	150W			✓
10241	LED36WPT50KMOG-G8	36W	5,200	144	5000K	>80	100-277V	EX39	50,000	150W			✓
12052	LED36WPT40KMOG-V-G9	36W	5,400	150	4000K	>80	277-480V	EX39	50,000	150W			✓
12053	LED36WPT50KMOG-V-G9	36W	5,400	150	5000K	>80	277-480V	EX39	50,000	150W			✓
11423	LED36WPTCCTMED-G8	36W	4,800	133	30/40/5000K	>80	120-277V	E26	50,000	150W	●	■	
11424	LED36WPTCCTMOG-G8	36W	4,800	133	30/40/5000K	>80	120-277V	EX39	50,000	150W	●	■	✓
10243	LED45WPT30KMOG-G8	45W	6,100	136	3000K	>80	100-277V	EX39	50,000	175W			✓
10245	LED45WPT40KMOG-G8	45W	6,300	140	4000K	>80	100-277V	EX39	50,000	175W			✓
10247	LED45WPT50KMOG-G8	45W	6,500	144	5000K	>80	100-277V	EX39	50,000	175W			✓
11425	LED45WPTCCTMED-G8	45W	6,100	136	30/40/5000K	>80	120-277V	E26	50,000	175W	●	■	
11426	LED45WPTCCTMOG-G8	45W	6,100	136	30/40/5000K	>80	120-277V	EX39	50,000	175W	●	■	✓
10249	LED54WPT30KMOG-G8	54W	7,300	135	3000K	>80	100-277V	EX39	50,000	200W			✓
10251	LED54WPT40KMOG-G8	54W	7,550	140	4000K	>80	100-277V	EX39	50,000	200W			✓
10253	LED54WPT50KMOG-G8	54W	7,800	144	5000K	>80	100-277V	EX39	50,000	200W			✓
12054	LED54WPT40KMOG-V-G9	54W	8,100	150	4000K	>80	277-480V	EX39	50,000	200W			✓
12055	LED54WPT50KMOG-V-G9	54W	8,100	150	5000K	>80	277-480V	EX39	50,000	200W			✓
11427	LED54WPTCCTMED-G8	54W	7,250	134	30/40/5000K	>80	120-277V	E26	50,000	200W	●	■	
11428	LED54WPTCCTMOG-G8	54W	7,250	134	30/40/5000K	>80	120-277V	EX39	50,000	200W	●	■	✓
11429	LED63WPTCCTMOG-G8	63W	8,500	135	30/40/5000K	>80	120-277V	EX39	50,000	250W	●	■	✓
<b>LARGE : 80W-120W</b>													
10260	LED80WPT40KMOG-G8	80W	10,400	130	4000K	>80	100-277V	EX39	50,000	320W			✓
10261	LED80WPT50KMOG-G8	80W	10,400	130	5000K	>80	100-277V	EX39	50,000	320W			✓
11430	LED80WPTCCTMOG-G8	80W	11,000	138	30/40/5000K	>80	120-277V	EX39	50,000	320W	●	■	✓
12056	LED100WPT40KMOG-V-G9	100W	15,000	150	4000K	>80	277-480V	EX39	50,000	400W			✓
12057	LED100WPT50KMOG-V-G9	100W	15,000	150	5000K	>80	277-480V	EX39	50,000	400W			✓
10254	LED100WPT30KMOG-G8	100W	13,000	130	3000K	>80	100-277V	EX39	50,000	400W			✓
10255	LED100WPT40KMOG-G8	100W	13,000	130	4000K	>80	100-277V	EX39	50,000	400W			✓
10256	LED100WPT50KMOG-G8	100W	13,000	130	5000K	>80	100-277V	EX39	50,000	400W			✓
11431	LED100WPTCCTMOG-G8	100W	13,500	135	30/40/5000K	>80	120-277V	EX39	50,000	400W	●	■	✓
10258	LED120WPT40KMOG-G8	120W	15,600	130	4000K	>80	100-277V	EX39	50,000	600W			✓
10259	LED120WPT50KMOG-G8	120W	15,600	130	5000K	>80	100-277V	EX39	50,000	600W			✓
11432	LED120WPTCCTMOG-G8	120W	16,000	133	30/40/5000K	>80	120-277V	EX39	50,000	600W	●	■	✓

\*NOTE: These products do not meet CEC Title 20 requirements and are not to be sold in the state of California, except when sold wholesale for final retail sale outside CA.

# PLUG-IN SENSORS

ORDER CODE	ITEM #	DESCRIPTION
10910	PT-SEN/PIR	LED HID Replacement Lamp Sensor PIR 3.5mm Plug w/PC
10911	PT-SEN/PC	LED HID Replacement Lamp Sensor PC 3.5mm Plug



PIR SENSOR



PC SENSOR

# PRODUCT DIMENSIONS

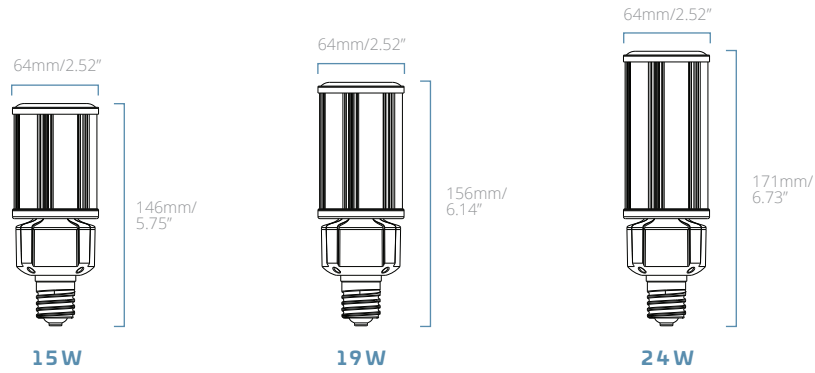

SMALL G7

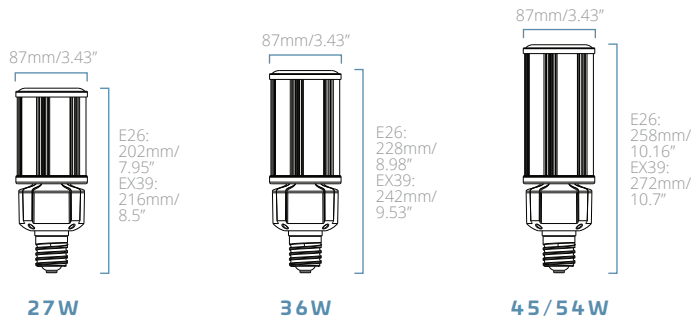

MEDIUM G7

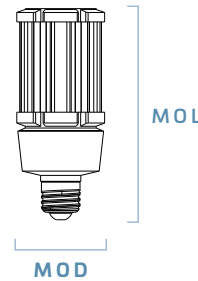

SIZE (WATTS)	MOL	MOD
27W	E26: 6.69"/170mm EX39: 7.28"/185mm	2.36"/60mm
36W	E26: 7.95"/202mm EX39: 8.7"/221mm	3.35"/85mm
45/54W	E26: 9.13"/232mm EX39: 9.88"/251mm	3.35"/85mm

MEDIUM G8

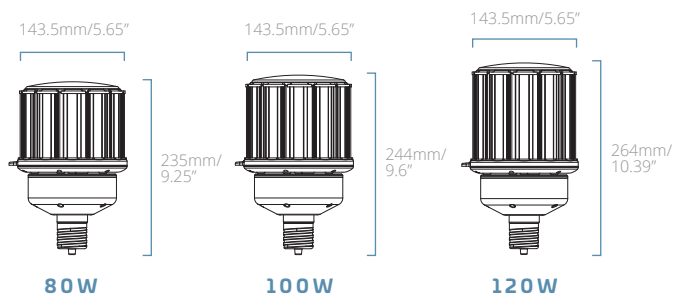

LARGE G7

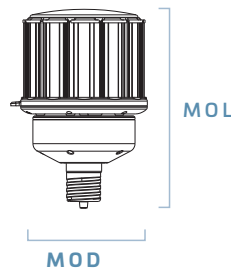

SIZE (WATTS)	MOL	MOD
80W	9.21"/234mm	5.87"/149mm
100W	9.57"/243mm	5.87"/149mm
120W	10.35"/263mm	5.87"/149mm

LARGE G8

# PRODUCT DIMENSIONS

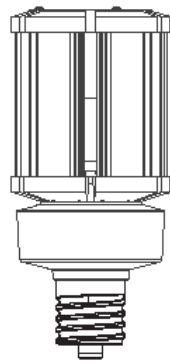

3.35"/85mm

**36W**

E26:  
7.76"/  
197mm  
EX39:  
8.7"/  
221mm

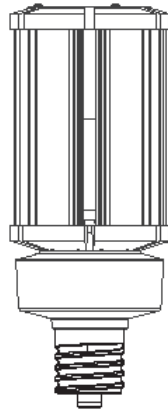

3.35"/85mm

**54W**

9.88"/  
251mm

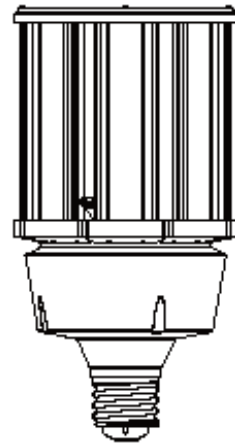

5.12"/130mm

**100W**

10.43"/  
265mm

## HIGH VOLTAGE G9

7.95"/  
202mm

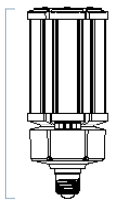

3.35"/85mm

**36W E26**

3.9"/  
99mm

9.13"/  
232mm

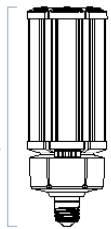

3.35"/85mm

**45/54W E26**

5.08"/  
129mm

9.72"/  
247mm

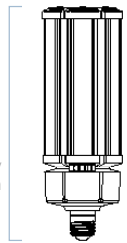

3.35"/85mm

**63W E26**

5.67"/  
144mm

8.5"/  
216mm

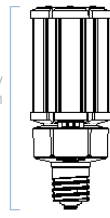

3.35"/85mm

**36W EX39**

3.9"/  
99mm

9.69"/  
246mm

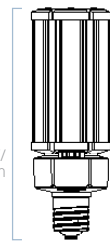

3.35"/85mm

**45/54W EX39**

5.08"/  
129mm

10.28"/  
261mm

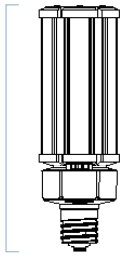

3.35"/85mm

**63W EX39**

5.67"/  
144mm

10.24"/  
260mm

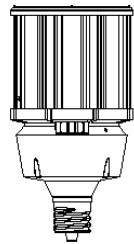

5.16"/131mm

**80W EX39**

10.83"/  
275mm

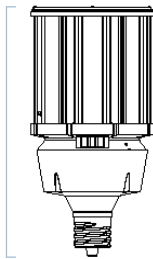

5.16"/131mm

**100W EX39**

11.61"/  
295mm

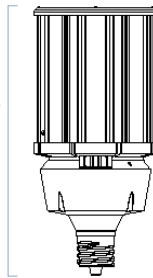

5.16"/131mm

**120W EX39**

## FIELDCCET