



# AAL1 Area Light

## HIGHLIGHTS

- Architectural thin profile used for area light applications
- Controls Ready makes adding controls quick and easy. Includes screw-in receptacle for Standalone sensors or Networked Lighting Controls
- NEMA 7-pin photocell receptacle available by factory modification
- T2, T3, T4, T5 lens optics available
- Multiple mounting options available for versatile use (mounts sold separately)
- Hinged toolless access junction box makes installation and maintenance easier
- Includes pre-installed 3.3ft (1m) power cord
- One: 1/2" side knockout
- PowerSet feature allows for multiple lumen stops out of the box
- FieldCCeT features provides multiple color temperature settings in one fixture

## CERTIFICATIONS

- UL listed for US & Canada
- RoHS Compliant
- FCC Compliant
- ICES-005 Compliant
- IP65 Rated
- IK08
- 3G Rated per ANSI C136.31
- DesignLights Consortium® Premium Qualified - meets the requirements for the highest DLC qualification for efficacy and lumen maintenance

## PERFORMANCE

- High Efficacy, up to 140 lm/W
- Available in fixed wattage models: 150, 200, 240, 300W and PowerSet models: power-selectable 100/80/60W, 150/130/100W, 300/240/200W, 450/400/350W
- Available in single CCT models: 3000, 4000, 5000K or FieldCCeT models: field-selectable 30/40/5000K
- CRI: >80
- Distribution Types: T2, T3, T4, T5
- Estimated L70: 100,000 Hours

## ELECTRICAL

- Input voltage: 120-277V or 277-480V
- 0-10V dimming, dim-to-off
- 12VDC Aux, 100mA max
- Surge Protection: 10kV included, 20kV (optional)
- Power factor: >0.9
- THD: <20%

## THERMAL

- -40°F to 122°F (-40°C to 50°C) ambient operating temperature
- Ambient operating temperature with sensor (see selected sensor datasheet)

## CONSTRUCTION

- Bronze powder coated die-cast aluminum housing
- Impact and UV resistant polycarbonate lens

## WARRANTY

- 5-Year limited warranty available [online](#). Contact your EiKO sales rep for additional details.

## KEY FEATURES

### CONTROLS READY

Easily add controls anytime without the need for additional wiring

### NEMA PHOTOCELL OPTIONAL

Factory installed NEMA 7-pin photocell receptacle paired with 3-pin photocell (on/off) or 5-pin photocell (dimming) allows for enhanced security and additional energy savings

### TOOLLESS JUNCTION BOX

Hinged toolless junction box makes installation and maintenance easier

### LENS SWAP COMBINED W/ ENVIRONMENTAL PROTECTION

T2, T3, T4, T5 (T2 & T4 available via factory mod). IP65, 3G, IK08 rated, powder coated die-cast bronze aluminum housing; impact and UV resistant polycarbonate lens.

project name	type
catalog number	voltage
approved by	date

100/80/60W



150W & 150/130/100W



200W, 240W, 300W & 300/240/200W



450/400/350W



RoHS Compliant



CAN ICES-005

IP65 IK08



## APPLICATIONS

- Parking Areas
- Automotive Dealerships
- Roadways
- Campuses
- Streetscapes
- Airports
- Area security lighting
- Building facades
- Signs
- Entryways

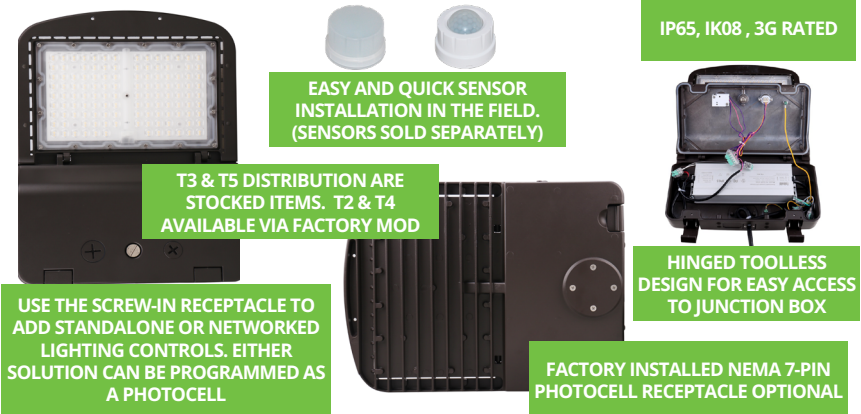

**AVAILABLE MODELS (\*PART NUMBERS AVAILABLE BY TAKING T3 OR T5 ITEM & SWAPPING OUT LENS OR DRIVERS VIA FACTORY MOD)**

ORDER	ORDER CODE	ITEM #	WATTS**	CCT***	LUMENS	EFFICACY (lm/W)	DIST. TYPE	VOLTAGE	TRADITIONAL WATTAGE EQUIVALENT	DLC ID #
										PREMIUM
	14702	AAL1-PS100-40T2-U*	100/80/60W	4000K	14,000/11,200/8400 lm	140 lm/W	T2	120-277V	up to 400W HID	S-4K0NFJ
	14703	AAL1-PS100-50T2-U*	100/80/60W	5000K	14,000/11,200/8400 lm	140 lm/W	T2	120-277V	up to 400W HID	S-ZTU3B1
	13607	AAL1-PS100-40T3-U	100/80/60W	4000K	14,000/11,200/8400 lm	140 lm/W	T3	120-277V	up to 400W HID	S-TNL7UW
	13609	AAL1-PS100-50T3-U	100/80/60W	5000K	14,000/11,200/8400 lm	140 lm/W	T3	120-277V	up to 400W HID	S-4M8NGL
	14721	AAL1-PS100-40T4-U*	100/80/60W	4000K	14,000/11,200/8400 lm	140 lm/W	T4	120-277V	up to 400W HID	S-RK7WIY
	14722	AAL1-PS100-50T4-U*	100/80/60W	5000K	14,000/11,200/8400 lm	140 lm/W	T4	120-277V	up to 400W HID	S-AX698Y
	13606	AAL1-PS100-40T5-U	100/80/60W	4000K	14,000/11,200/8400 lm	140 lm/W	T5	120-277V	up to 400W HID	S-8NQI0S
	13608	AAL1-PS100-50T5-U	100/80/60W	5000K	14,000/11,200/8400 lm	140 lm/W	T5	120-277V	up to 400W HID	S-DCJSRO
	14690	AAL1-150-40T2-U*	150W	4000K	21,000 lm	140 lm/W	T2	120-277V	400W HID	S-TM10OJ
	14691	AAL1-150-40T2-V*	150W	4000K	21,000 lm	140 lm/W	T2	277-480V	400W HID	S-20KWTY
	14692	AAL1-150-50T2-U*	150W	5000K	21,000 lm	140 lm/W	T2	120-277V	400W HID	S-S15D4B
	14693	AAL1-150-50T2-V*	150W	5000K	21,000 lm	140 lm/W	T2	277-480V	400W HID	S-90ZD58
	13579	AAL1-150-40T3-U	150W	4000K	21,000 lm	140 lm/W	T3	120-277V	400W HID	S-Q9JZ2H
	13583	AAL1-150-40T3-V	150W	4000K	21,000 lm	140 lm/W	T3	277-480V	400W HID	S-JM7QRI
	13585	AAL1-150-50T3-U	150W	5000K	21,000 lm	140 lm/W	T3	120-277V	400W HID	S-WS8PV9
	13587	AAL1-150-50T3-V	150W	5000K	21,000 lm	140 lm/W	T3	277-480V	400W HID	S-KJIELX
	14710	AAL1-150-40T4-U*	150W	4000K	21,000 lm	140 lm/W	T4	120-277V	400W HID	S-5P39WX
	14711	AAL1-150-40T4-V*	150W	4000K	21,000 lm	140 lm/W	T4	277-480V	400W HID	S-U0CD6Q
	14712	AAL1-150-50T4-U*	150W	5000K	21,000 lm	140 lm/W	T4	120-277V	400W HID	S-L3A76D
	14713	AAL1-150-50T4-V*	150W	5000K	21,000 lm	140 lm/W	T4	277-480V	400W HID	S-3NJYE7
	13578	AAL1-150-40T5-U	150W	4000K	21,000 lm	140 lm/W	T5	120-277V	400W HID	S-9GWLNQ
	13582	AAL1-150-40T5-V	150W	4000K	21,000 lm	140 lm/W	T5	277-480V	400W HID	S-TCGADO
	13584	AAL1-150-50T5-U	150W	5000K	21,000 lm	140 lm/W	T5	120-277V	400W HID	S-6JKWP4
	13586	AAL1-150-50T5-V	150W	5000K	21,000 lm	140 lm/W	T5	277-480V	400W HID	S-17HTDJ
	14704	AAL1-PS150-FCCTT2-U*	150/130/100W	3000/4000/5000K	21,000/18,200/14,000 lm	140 lm/W	T2	120-277V	up to 400W HID	S-FAL057
	14705	AAL1-PS150-FCCTT2-V*	150/130/100W	3000/4000/5000K	21,000/18,200/14,000 lm	140 lm/W	T2	277-480V	up to 400W HID	S-MVWK28
	13621	AAL1-PS150-FCCTT3-U	150/130/100W	3000/4000/5000K	21,000/18,200/14,000 lm	140 lm/W	T3	120-277V	up to 400W HID	S-HCIM8B
	14681	AAL1-PS150-FCCTT3-V	150/130/100W	3000/4000/5000K	21,000/18,200/14,000 lm	140 lm/W	T3	277-480V	up to 400W HID	S-YGKEH2
	14723	AAL1-PS150-FCCTT4-U*	150/130/100W	3000/4000/5000K	21,000/18,200/14,000 lm	140 lm/W	T4	120-277V	up to 400W HID	S-XM3WLQ
	14724	AAL1-PS150-FCCTT4-V*	150/130/100W	3000/4000/5000K	21,000/18,200/14,000 lm	140 lm/W	T4	277-480V	up to 400W HID	S-T8OWUV
	13614	AAL1-PS150-30T5-U	150/130/100W	3000K	21,000/18,200/14,000 lm	140 lm/W	T5	120-277V	up to 400W HID	S-QM241F
	13620	AAL1-PS150-FCCTT5-U	150/130/100W	3000/4000/5000K	21,000/18,200/14,000 lm	140 lm/W	T5	120-277V	up to 400W HID	S-W1RAHP
	14679	AAL1-PS150-FCCTT5-V	150/130/100W	3000/4000/5000K	21,000/18,200/14,000 lm	140 lm/W	T5	277-480V	up to 400W HID	S-E429BI
	14694	AAL1-200-40T2-U*	200W	4000K	28,000 lm	140 lm/W	T2	120-277V	750W HID	S-H3O9PV
	14695	AAL1-200-50T2-U*	200W	5000K	28,000 lm	140 lm/W	T2	120-277V	750W HID	S-T73N1S
	13589	AAL1-200-40T3-U	200W	4000K	28,000 lm	140 lm/W	T3	120-277V	750W HID	S-S5N7LK
	13591	AAL1-200-50T3-U	200W	5000K	28,000 lm	140 lm/W	T3	120-277V	750W HID	S-7BOC1D
	14714	AAL1-200-40T4-U*	200W	4000K	28,000 lm	140 lm/W	T4	120-277V	750W HID	S-A2LU6C
	14715	AAL1-200-50T4-U*	200W	5000K	28,000 lm	140 lm/W	T4	120-277V	750W HID	S-WJD5S7
	13588	AAL1-200-40T5-U	200W	4000K	28,000 lm	140 lm/W	T5	120-277V	750W HID	S-N41QZV
	13590	AAL1-200-50T5-U	200W	5000K	28,000 lm	140 lm/W	T5	120-277V	750W HID	S-LK6DNG
	14696	AAL1-240-40T2-U*	240W	4000K	33,600 lm	140 lm/W	T2	120-277V	1000W HID	S-FBT74M
	14697	AAL1-240-50T2-U*	240W	5000K	33,600 lm	140 lm/W	T2	120-277V	1000W HID	S-K80GQC
	13593	AAL1-240-40T3-U	240W	4000K	33,600 lm	140 lm/W	T3	120-277V	1000W HID	S-QO8BTF
	13595	AAL1-240-50T3-U	240W	5000K	33,600 lm	140 lm/W	T3	120-277V	1000W HID	S-M0DE1R
	14716	AAL1-240-40T4-U*	240W	4000K	33,600 lm	140 lm/W	T4	120-277V	1000W HID	S-RFAPVM
	14717	AAL1-240-50T4-U*	240W	5000K	33,600 lm	140 lm/W	T4	120-277V	1000W HID	S-U102KX
	13592	AAL1-240-40T5-U	240W	4000K	33,600 lm	140 lm/W	T5	120-277V	1000W HID	S-ANTOU3
	13594	AAL1-240-50T5-U	240W	5000K	33,600 lm	140 lm/W	T5	120-277V	1000W HID	S-EYD3NP
	14698	AAL1-300-40T2-U*	300W	4000K	42,000 lm	140 lm/W	T2	120-277V	1000W HID	S-K76U0R
	14699	AAL1-300-40T2-V*	300W	4000K	42,000 lm	140 lm/W	T2	277-480V	1000W HID	S-V12GL7
	14700	AAL1-300-50T2-U*	300W	5000K	42,000 lm	140 lm/W	T2	120-277V	1000W HID	S-UQ4PJA

\*\* All power-selectable fixtures ship at the highest wattage setting

\*\*\* All CCT-selectable fixtures ship at 5000K

## AVAILABLE MODELS (\*PART NUMBERS AVAILABLE BY TAKING T3 OR T5 ITEM & SWAPPING OUT LENS OR DRIVERS VIA FACTORY MOD)

ORDER	ORDER CODE	ITEM #	WATTS**	CCT***	LUMENS	EFFICACY (lm/W)	DIST. TYPE	VOLTAGE	TRADITIONAL WATTAGE EQUIVALENT	DLC ID #	
										PREMIUM	
	14701	AAL1-300-50T2-V*	300W	5000K	42,000 lm	140 lm/W	T2	277-480V	1000W HID	S-TZ1CM2	
	13597	AAL1-300-40T3-U	300W	4000K	42,000 lm	140 lm/W	T3	120-277V	1000W HID	S-7XO2ZQ	
	13601	AAL1-300-40T3-V	300W	4000K	42,000 lm	140 lm/W	T3	277-480V	1000W HID	S-KZOMAC	
	13603	AAL1-300-50T3-U	300W	5000K	42,000 lm	140 lm/W	T3	120-277V	1000W HID	S-ZFUR6M	
	13605	AAL1-300-50T3-V	300W	5000K	42,000 lm	140 lm/W	T3	277-480V	1000W HID	S-8OAY3R	
	14544	AAL1-300-40T4-U*	300W	4000K	42,000 lm	140 lm/W	T4	120-277V	1000W HID	S-2B31ME	
	14718	AAL1-300-40T4-V*	300W	4000K	42,000 lm	140 lm/W	T4	277-480V	1000W HID	S-ZHGMEN	
	14719	AAL1-300-50T4-U*	300W	5000K	42,000 lm	140 lm/W	T4	120-277V	1000W HID	S-QDTMA2	
	14720	AAL1-300-50T4-V*	300W	5000K	42,000 lm	140 lm/W	T4	277-480V	1000W HID	S-1ID7HC	
	13596	AAL1-300-40T5-U	300W	4000K	42,000 lm	140 lm/W	T5	120-277V	1000W HID	S-H9J16Z	
	13600	AAL1-300-40T5-V	300W	4000K	42,000 lm	140 lm/W	T5	277-480V	1000W HID	S-FWHQJC	
	13602	AAL1-300-50T5-U	300W	5000K	42,000 lm	140 lm/W	T5	120-277V	1000W HID	S-AU95FD	
	13604	AAL1-300-50T5-V	300W	5000K	42,000 lm	140 lm/W	T5	277-480V	1000W HID	S-O0TP5G	
	13616	AAL1-PS300-30T5-U	300/240/200W	3000K	42,000/33,600/28,000 lm	140 lm/W	T5	120-277V	up to 1000W HID	S-P01G86	
	14706	AAL1-PS300-FCCTT2-U*	300/240/200W	3000/4000/5000K	42,000/33,600/28,000 lm	140 lm/W	T2	120-277V	up to 1000W HID	S-35LX4G	
	14707	AAL1-PS300-FCCTT2-V*	300/240/200W	3000/4000/5000K	42,000/33,600/28,000 lm	140 lm/W	T2	277-480V	up to 1000W HID	S-RB70EY	
	13625	AAL1-PS300-FCCTT3-U	300/240/200W	3000/4000/5000K	42,000/33,600/28,000 lm	140 lm/W	T3	120-277V	up to 1000W HID	S-3ZO652	
	14682	AAL1-PS300-FCCTT3-V	300/240/200W	3000/4000/5000K	42,000/33,600/28,000 lm	140 lm/W	T3	277-480V	up to 1000W HID	S-19YBDT	
	14725	AAL1-PS300-FCCTT4-U*	300/240/200W	3000/4000/5000K	42,000/33,600/28,000 lm	140 lm/W	T4	120-277V	up to 1000W HID	S-Y8OZBE	
	14726	AAL1-PS300-FCCTT4-V*	300/240/200W	3000/4000/5000K	42,000/33,600/28,000 lm	140 lm/W	T4	277-480V	up to 1000W HID	S-98YE5P	
	13624	AAL1-PS300-FCCTT5-U	300/240/200W	3000/4000/5000K	42,000/33,600/28,000 lm	140 lm/W	T5	120-277V	up to 1000W HID	S-0L181D	
	14680	AAL1-PS300-FCCTT5-V	300/240/200W	3000/4000/5000K	42,000/33,600/28,000 lm	140 lm/W	T5	277-480V	up to 1000W HID	S-UH9T73	
	14708	AAL1-PS450-40T2-U*	450/400/350W	4000K	63,000/56,000/49,000 lm	140 lm/W	T2	120-277V	up to 1000W HID	S-A9JRF0	
	14709	AAL1-PS450-50T2-U*	450/400/350W	5000K	63,000/56,000/49,000 lm	140 lm/W	T2	120-277V	up to 1000W HID	S-T5FB7H	
	13611	AAL1-PS450-40T3-U	450/400/350W	4000K	63,000/56,000/49,000 lm	140 lm/W	T3	120-277V	up to 1000W HID	S-U0CAOE	
	13613	AAL1-PS450-50T3-U	450/400/350W	5000K	63,000/56,000/49,000 lm	140 lm/W	T3	120-277V	up to 1000W HID	S-9MF6B5	
	14545	AAL1-PS450-40T4-U*	450/400/350W	4000K	63,000/56,000/49,000 lm	140 lm/W	T4	120-277V	up to 1000W HID	S-48FHMI	
	14727	AAL1-PS450-50T4-U*	450/400/350W	5000K	63,000/56,000/49,000 lm	140 lm/W	T4	120-277V	up to 1000W HID	S-ZS7CU4	
	13610	AAL1-PS450-40T5-U	450/400/350W	4000K	63,000/56,000/49,000 lm	140 lm/W	T5	120-277V	up to 1000W HID	S-6B5FYO	
	13612	AAL1-PS450-50T5-U	450/400/350W	5000K	63,000/56,000/49,000 lm	140 lm/W	T5	120-277V	up to 1000W HID	S-M84KLO	
	14913	AAL1-PS450-40T2-V*	450/400/350W	4000K	63,000/56,000/49,000 lm	140 lm/W	T2	277-480V	up to 1000W HID	S-4JQKMD	
	14906	AAL1-PS450-50T2-V*	450/400/350W	5000K	63,000/56,000/49,000 lm	140 lm/W	T2	277-480V	up to 1000W HID	S-X0T3S7	
	14911	AAL1-PS450-40T3-V*	450/400/350W	4000K	63,000/56,000/49,000 lm	140 lm/W	T3	277-480V	up to 1000W HID	S-S6FQPN	
	14907	AAL1-PS450-50T3-V*	450/400/350W	5000K	63,000/56,000/49,000 lm	140 lm/W	T3	277-480V	up to 1000W HID	S-XLZ7PR	
	14912	AAL1-PS450-40T4-V*	450/400/350W	4000K	63,000/56,000/49,000 lm	140 lm/W	T4	277-480V	up to 1000W HID	S-OQRISZ	
	14908	AAL1-PS450-50T4-V*	450/400/350W	5000K	63,000/56,000/49,000 lm	140 lm/W	T4	277-480V	up to 1000W HID	S-D4LYGX	
	14910	AAL1-PS450-40T5-V*	450/400/350W	4000K	63,000/56,000/49,000 lm	140 lm/W	T5	277-480V	up to 1000W HID	S-ES70GT	
	14909	AAL1-PS450-50T5-V*	450/400/350W	5000K	63,000/56,000/49,000 lm	140 lm/W	T5	277-480V	up to 1000W HID	S-2TNQVL	

\*\* All power-selectable fixtures ship at the highest wattage setting

\*\*\* All CCT-selectable fixtures ship at 5000K

FACTORY INSTALLED OPTIONS	
SURGE PROTECTION	CONTROLS*
<p><b>[Blank]</b> : Default 10kV surge protection</p> <p><b>SP2</b> : 20kV surge protection</p>	<p><b>[Blank]</b> : Default, no socket, no photocell</p> <p><b>PC4</b> : 3-pin NEMA Twist-lock Premium Photocell LED4537SC, 347-480V, 2A</p> <p><b>PC6</b> : 3-pin NEMA Twist-lock Photocell, 120-277V, 5A and 120W+ only</p> <p><b>PC7</b> : 3-pin NEMA Twist-lock Photocell, 120-277V, 5A</p> <p><b>PC9</b> : 5-pin NEMA Twist-lock Photocell, 0-10V Dimmable, 120-277V, 5A</p> <p><b>PC10</b> : 5-pin NEMA Twist-lock Photocell, 0-10V Dimmable, 347-480V, 2A</p>





\* **Note:** PC4-PC10 comes with a NEMA 7-pin receptacle allowing for the photocell to be added or replaced in the field. If using NEMA photocell along with motion sensor, motion sensor will only be activated once the photocell has been activated.

MODEL CONFIGURATOR							FACTORY INSTALLED OPTIONS				
MODEL	-	WATTS	-	CCT	DIST. TYPE	-	VOLTAGE	-	SURGE PROTECTION	-	CONTROLS
AAL1	-		-			-		-		-	

EXAMPLE PART NUMBER: PART NUMBER FROM AVAILABLE MODELS FOLLOWED BY -SP2-PC1



REFER TO FOLLOWING SECTIONS FOR DETAILS ON FACTORY INSTALLED OPTIONS & AVAILABLE FIELD INSTALLED OPTIONS

## MOUNTS & ACCESSORIES\* (FOR POLE ADAPTERS AND MOUNTS SEE PA1 SPEC SHEET)

ORDER	ORDER CODE	ITEM #	DESCRIPTION	
	13804	AAL1-SF	AAL1 Slip fitter mount, up to 2 3/8" tenon top, bronze	
	13805	AAL1-MA	AAL1 Adjustable direct mounting arm, bronze	
	13806	AAL1-TR	AAL1 Trunion mount, bronze	
	13807	AAL1-FM	AAL1 Fixed direct mounting arm, bronze	

\*A mount is required when ordering. The fixture does not come with a mount.

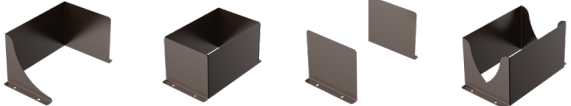
## SHIELDS

ORDER	ORDER CODE	ITEM #	DESCRIPTION	
AVAILABLE LATE Q2	15002	AAL1-SHIELD-S	AAL1 100W 4Pcs Shield Kit	
AVAILABLE LATE Q2	15004	AAL1-SHIELD-M	AAL1 150W 4Pcs Shield Kit	
AVAILABLE LATE Q2	15006	AAL1-SHIELD-L	AAL1 200/240/300W 4Pcs Shield Kit	
AVAILABLE LATE Q2	15008	AAL1-SHIELD-XL	AAL1 450W 4Pcs Shield Kit	

## LENSES\* : FACTORY INSTALLED

ORDER	ORDER CODE	ITEM #	DESCRIPTION
	14510	AAL1-LENS-S-T2	AAL1 Lens, T2, 100W
	14511	AAL1-LENS-M-T2	AAL1 Lens, T2, 150W
	14512	AAL1-LENS-L-T2	AAL1 Lens, T2, 200W, 240W, 300W
	14513	AAL1-LENS-S-T4	AAL1 Lens, T4, 100W
	14514	AAL1-LENS-XL-T2	AAL1 Lens, T2, 450W, 2 needed per fixture
	14515	AAL1-LENS-M-T4	AAL1 Lens, T4, 150W
	14516	AAL1-LENS-L-T4	AAL1 Lens, T4, 200W, 240W, 300W
	14517	AAL1-LENS-XL-T4	AAL1 Lens, T4, 450W, 2 needed per fixture

\*Note: Part numbers are for inventory reference only, lenses are factory installed by mounting to the T3 or T5 model of AAL1

**AAL1-LENS-S-T2**

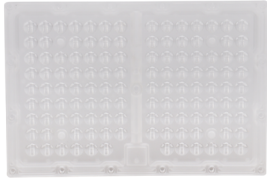

**AAL1-LENS-M-T2**

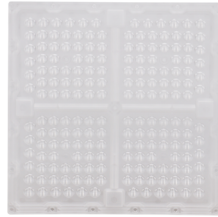

**AAL1-LENS-L-T2**



**AAL1-LENS-XL-T2**

*2 needed per fixture*

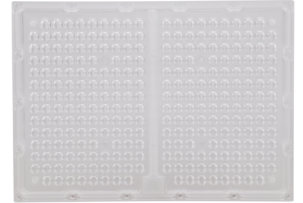

**AAL1-LENS-S-T4**

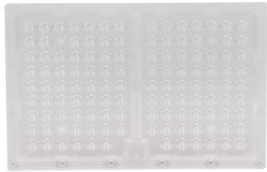

**AAL1-LENS-M-T4**

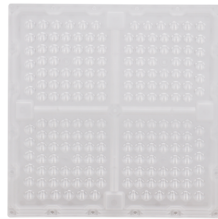

**AAL1-LENS-L-T4**

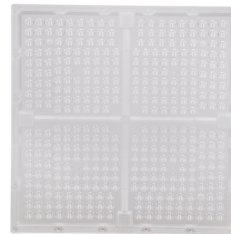

**AAL1-LENS-XL-T4**

*2 needed per fixture*

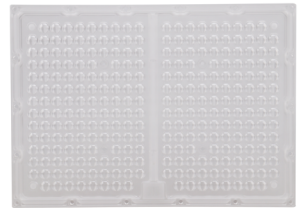

## CONTROLS & SENSORS: FIELD OR FACTORY INSTALLED

ORDER	ORDER CODE	ITEM #	DESCRIPTION	FACTORY INSTALLED CODE
<b>STANDALONE CONTROLS</b>				
<b>PHOTOCELL VIA NEMA 7-PIN RECEPTACLE</b>				
	10204	LED4537SC	3-pin NEMA Twist-lock Premium Photocell LED4537SC, 347-480V, 2A, 12-year Warranty.	PC4
	14947	JL-205C	3-pin NEMA Twist-lock Photocell, 120-277V, 5A and 120W+ only, 2-year Warranty.	PC6
	14948	JL-207C	3-pin NEMA Twist-lock Photocell, 120-277V, 5A, 5-year Warranty.	PC7
	14949	JL-207F	3-pin NEMA Twist-lock Photocell, 120-480V, 5A, 5-year Warranty.	PC8
	801337	JL-242C	5-pin NEMA Twist-lock Photocell, 0-10V Dimmable, 120-277V, 5A, 5-year Warranty.	PC9
	801338	JL-242F	5-pin NEMA Twist-lock Photocell, 0-10V Dimmable, 347-480V, 2A, 5-year Warranty.	PC10
* <b>NOTE:</b> PC4-P10 comes with a NEMA 7-pin receptacle allowing for the photocell to be added or replaced in the field. If using NEMA photocell along with motion sensor, motion sensor will only be activated once the photocell has been activated.				
<b>PLUG AND PLAY SENSORS</b>				
	14916	SEN5A-SPCR-WH	Stand-alone Photocell Sensor, 12-24V, Screw-in, White, IP65 (Optional Parameters set by SEN5A-ACT)	---
	13861	SEN5A-SPPR-WH	Stand-alone PIR Motion Sensor, 12-24V, Screw-in, 0-10V, Daylight Harvesting, 8-40ft, White, IP65, Parameters set by SEN5A-ACT.	---
	13859	SEN5A-SPMR-WH*	Stand-alone Microwave Motion Sensor, 12-24V, Screw-in, 0-10V, Daylight Harvesting, 8-40ft, White, IP65, Parameters set by SEN5A-ACT.	---
* Microwave sensors should not be installed near moving objects such as trees, motors, or fans to avoid false activation.				
<b>REMOTES FOR COMMISSIONING PLUG AND PLAY SENSORS</b>				
	13344	SEN5A-ACT	Commissioning Tool for SEN5A, BAY-E-SEN/PIR, BAY-E-SEN/M, and MS2-DPX-3. (Backward compatible with SEN5A/CT and RC-100)	---
<b>NETWORKED LIGHTING CONTROLS (NLC)</b>				
<b>PLUG AND PLAY SENSOR</b>				
	13865	SENA-WPPA-WH	BLE PIR Motion sensor, 12-24V, Screw-in, 0-10V, Daylight Harvesting, 8-40ft, White, IP65, Parameters set by Silvoir App	---
<b>WALL OR WIRELESS CONTROLLERS</b>				
	12654	ESRPB-W-EO	BLE Easyfit by EnOcean wireless self-powered kinetic Single rocker pad, white, wall plate included.	---
	12655	EDRPB-W-EO	BLE Easyfit by EnOcean wireless self-powered kinetic Double rocker pad, white, wall plate included.	---
	12635	PSC-DM-WS-100-BLE-SR	BLE TruBlu 120-277V, Single Gang Single Button Wall Controller, White, Parameters set by Silvoir App.	---
	12636	PSC-DM-I-WS-100-BLE-SR	BLE TruBlu PIR Occupancy/ Vacancy Sensor, 120-277V, Single Gang Wall Controller, White, Parameters set by Silvoir App.	---
	12637	PSC-DM-WS-400-BLE-SR	BLE TruBlu 4-Button Wall Controller, 120-277V, Single Gang, White, Parameters set by Silvoir App.	---
<b>GATEWAY AND RANGE EXTERENDER</b>				
	13234	SGW-101	BLE Silvoir Gateway SGW-101 Manufactured by Rigado (model: Cascade-500). 5-year from Silvoir warranty and tech support.	---
	12994	PSC-RET-100-BLE-SR	BLE TruBlu Range Extender, 120-277V, 800ft, NEMA 4X Outdoor Enclosure	---
	12993	PSC-TKP-200-BLE-SR	BLE TruBlu Battery Backup Timekeeper and Range Extender, 120V, 800ft, NEMA 4X Outdoor Enclosure	---

# PRODUCT DIMENSIONS

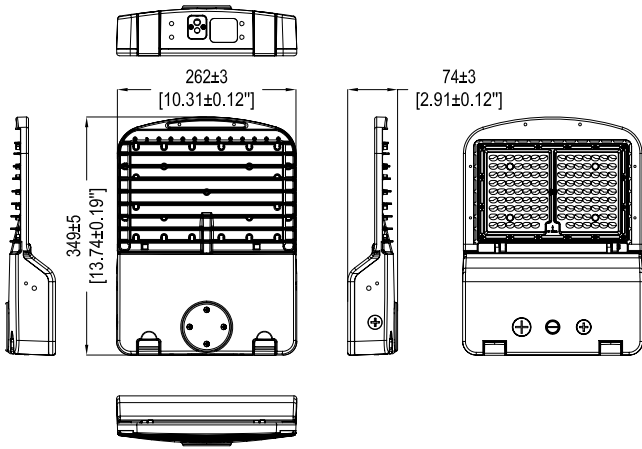

100/80/60W

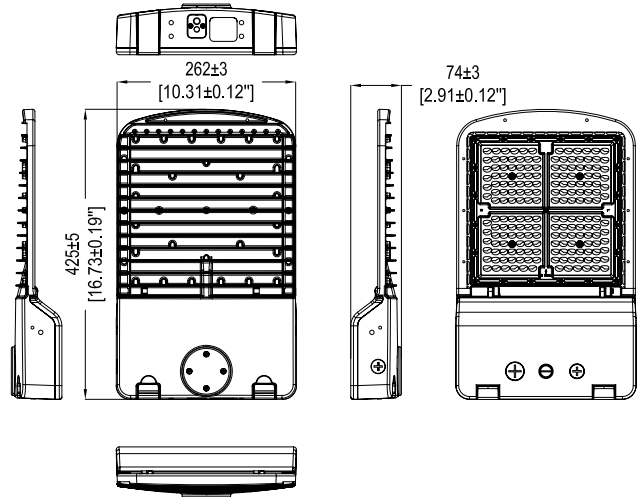

150W & 150/130/100W

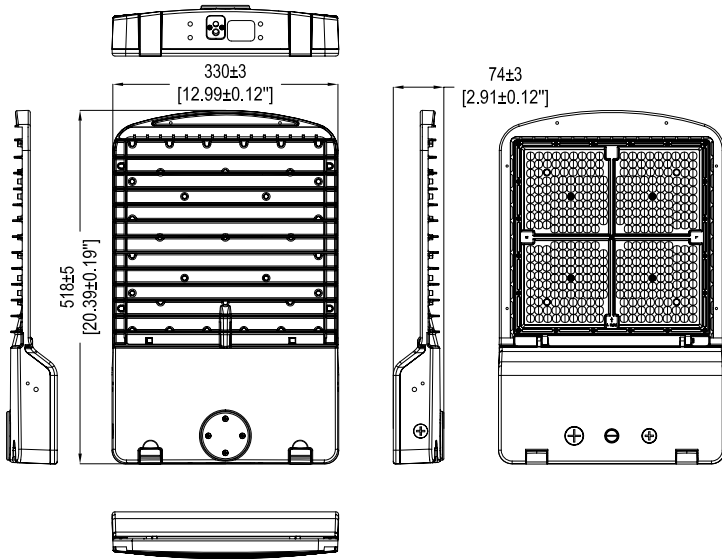

200W, 240W, 300W & 300/240/200W

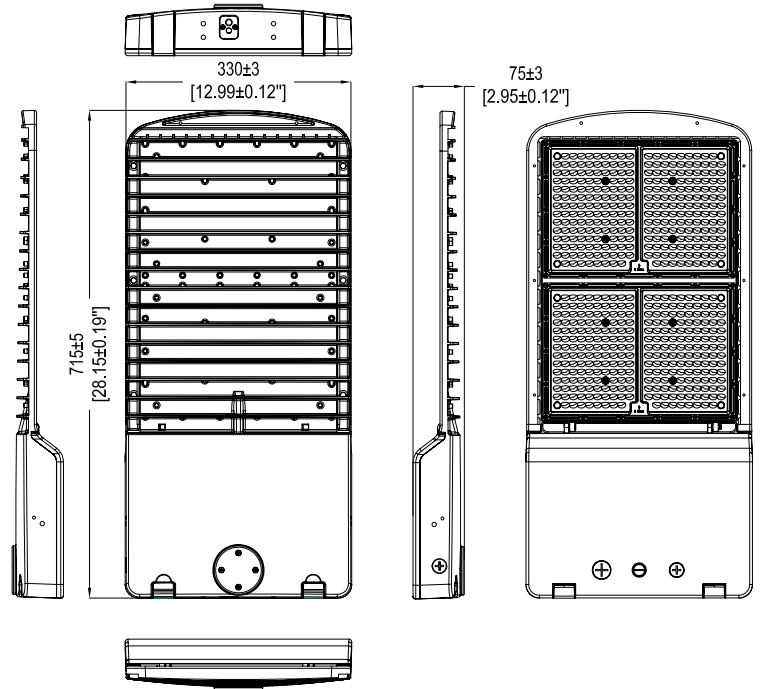

450/400/350W

# MOUNT DIMENSIONS

## SLIPFITTER MOUNT

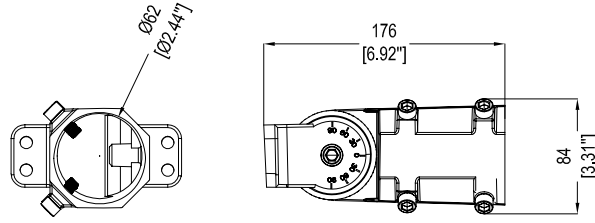

## ADJUSTABLE DIRECT MOUNTING ARM

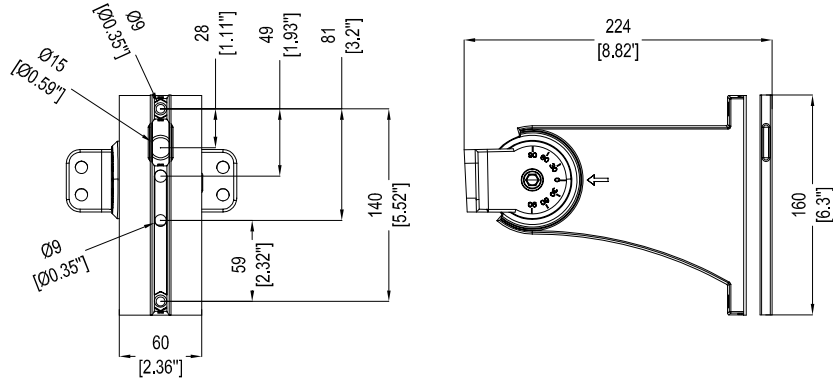

## TRUNNION MOUNT

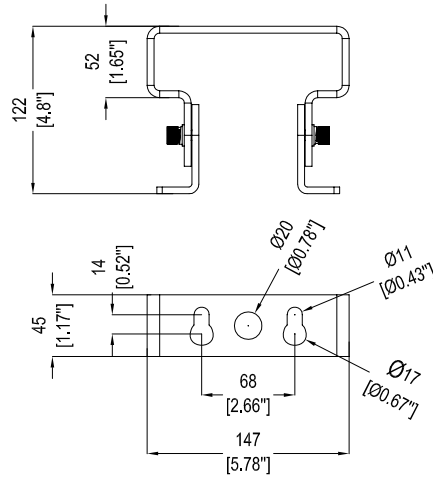

## DIRECT MOUNTING ARM

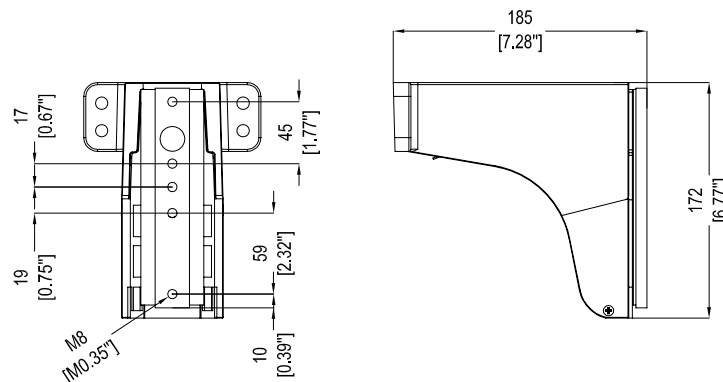



## CONFIGURATIONS (MOUNTS ORDERED SEPARATELY AND FIELD INSTALLED)

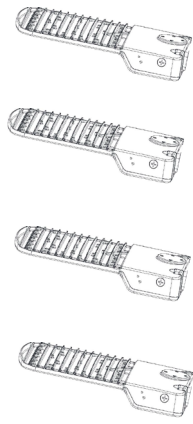

### SLIP FITTER MOUNT

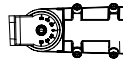

### ADJUSTABLE DIRECT MOUNT

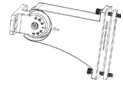

### TRUNNION MOUNT



### DIRECT MOUNT

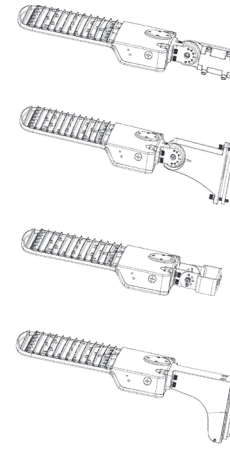
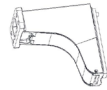

## MOUNTING CONFIGURATIONS

### 100/80/60W



S Single  
EPA: 0.59  
7.33lbs/3.33kg



D90 Double 90°  
EPA: 0.75  
14.65lbs/6.66kg



D180 Double 180°  
EPA: 0.98  
14.65lbs/6.66kg



T90 Triple 90°  
EPA: 1.15  
21.98lbs/9.99kg



T90 Triple 120°  
EPA: 1.24  
21.98lbs/9.99kg



Q90 Quad 90°  
EPA: 1.15  
29.30lbs/13.32kg

### 150W & 150/130/100W



S Single  
EPA: .59  
8.71lbs/3.96kg



D90 Double 90°  
EPA: .92  
17.42lbs/7.92kg



D180 Double 180°  
EPA: 1.19  
17.42lbs/ 7.92kg



T90 Triple 90°  
EPA: 1.40  
26.14lbs/11.88kg



T90 Triple 120°  
EPA: 1.50  
26.14lbs/11.88kg



Q90 Quad 90°  
EPA: 1.40  
34.85lbs/15.84kg

### 200W, 240W, 300W & 300/240/200W



S Single  
EPA: .72  
10.52lbs/4.78kg



D90 Double 90°  
EPA: 1.12  
21.03lbs/ 9.56kg



D180 Double 180°  
EPA: 1.45  
21.03lbs/9.56kg



T90 Triple 90°  
EPA: 1.70  
31.55lbs/14.34kg

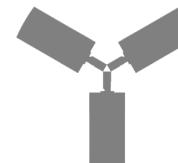

T90 Triple 120°  
EPA: 1.83  
31.55lbs/14.34kg



Q90 Quad 90°  
EPA: 1.70  
42.06lbs/ 9.12kg

### 450/400/350W



S Single  
EPA: .98  
16.08lbs/ 7.31kg



D90 Double 90°  
EPA: 1.53  
32.16lbs/14.62kg



D180 Double 180°  
EPA: 1.99  
32.16lbs/14.62kg



T90 Triple 90°  
EPA: 2.34  
48.25lbs/21.93kg

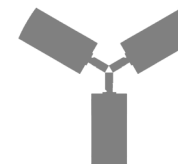

T90 Triple 120°  
EPA: 2.52  
48.25lbs/21.93kg



Q90 Quad 90°  
EPA: 2.34  
63.33lbs/29.24kg

## DISTRIBUTION & PHOTOMETRICS

(VISIT [EIKO.COM](http://EIKO.COM) TO CREATE A FREE PHOTOMETRIC LIGHTING LAYOUT OR REACH OUT TO YOUR REGIONAL ACCOUNT SPECIALIST FOR ASSISTANCE). ALL IES FILES CAN BE FOUND AT [EIKO.COM](http://EIKO.COM).

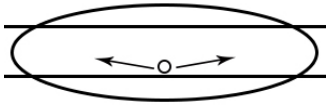

Type II

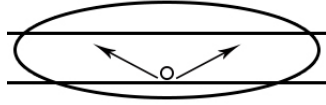

Type III

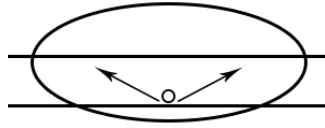

Type IV

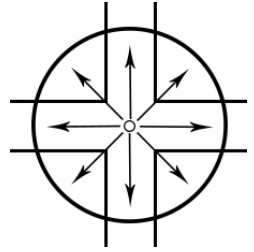

Type V