



# LED STRIP TAPES, EXTRUSIONS & POWER SUPPLIES





# CONTENTS

- 4    LOW VOLTAGE TAPE SYSTEMS**
- 10    LOW VOLTAGE LED TAPES**
- 22    EXTRUSIONS, LENSES & END CAPS**
- 26    CONNECTORS, WIRES & ACCESSORIES**
- 30    LINE VOLTAGE TAPE SYSTEMS**
- 32    LINE VOLTAGE TAPE**
- 34    LINE VOLTAGE EXTRUSION, LENS & ACCESSORIES**
- 36    LED TAPE KITS**
- 42    POWER SUPPLIES**





# LOW VOLTAGE TAPE SYSTEMS

## LED STRIPS, EXTRUSIONS & ACCESSORIES

Stanpro's Low Voltage LED tapes are a great way to complete lighting projects which are easy to combine, install and plan. These professional grade flexible LED strips provide a uniform, high quality light that is perfect for adding a touch of elegance and warmth to any room, creating a cozy atmosphere.

The LED tape strips are offered in a wide selection of color temperatures in the range of 2 400 K to 5 000 K and RGB to suit any application with a high CRI. In addition, offering IP22 and IP67 sealed LED strips. A variety of compatible components and accessories are offered to expand possibilities with the accommodating drivers, extrusions and mounting options to allow the customization of any application.

Easy to use and handle with the reliability and flexibility of our product guides. Create a simple lighting solution or dive into more complex projects, Stanpro has the perfect solution for every need.



# PRE-ASSEMBLED CUSTOM SOLUTION

## Low Voltage LED Tape and Extrusion

Stanpro's fully assembled, made-to-order lighting system, offers customization for a variety of applications. Includes all the required components for the perfect modern lighting: housing extrusion, LED strip tape, lens, and brackets. Simple and easy to install, that will draw attention to any environment. Perfect for residential, commercial, and industrial spaces, transforming lighting into a work of art.

- Extrusions, 7 different series
- Lenses, variation to match profiles
- Low voltage LED Tapes IP22
- Luminous output up to 314 lm/ft.
- Dimmable
- Multiple installation accessories
- Surfaced, coved, corner and recessed mounting
- Meets North American woodworking standards
- Suitable for use in a clothes closet storage area



For each of our extrusions series a detailed ordering guide containing all compatible components is listed. Simply indicate the required components with the quick order codes and add the length required.

TP — [ ] — [ ] — A — [ ] / [ ] [ ] D / [ ] [ ]

Series	EXTRUSION TYPE				Length	LED TAPE			WIRE FEED	
	Extrusion	Lens	Finish	Fixing Clips		Lumens	Color temp. (K)	Usage	Lead In	Lead Out

## LAYOUT DESIGN

When ordering an assembly that requires multiple lengths or a complex configuration, to be used with or without connectors, please specify the desired lighting layout along with the lengths by using the form below. Provide it to your sales representative for a customized quote.

# CONFIGURE A COMPLETE LED TAPE SYSTEM

## STEP BY STEP GUIDE TO A CUSTOMIZED SOLUTION

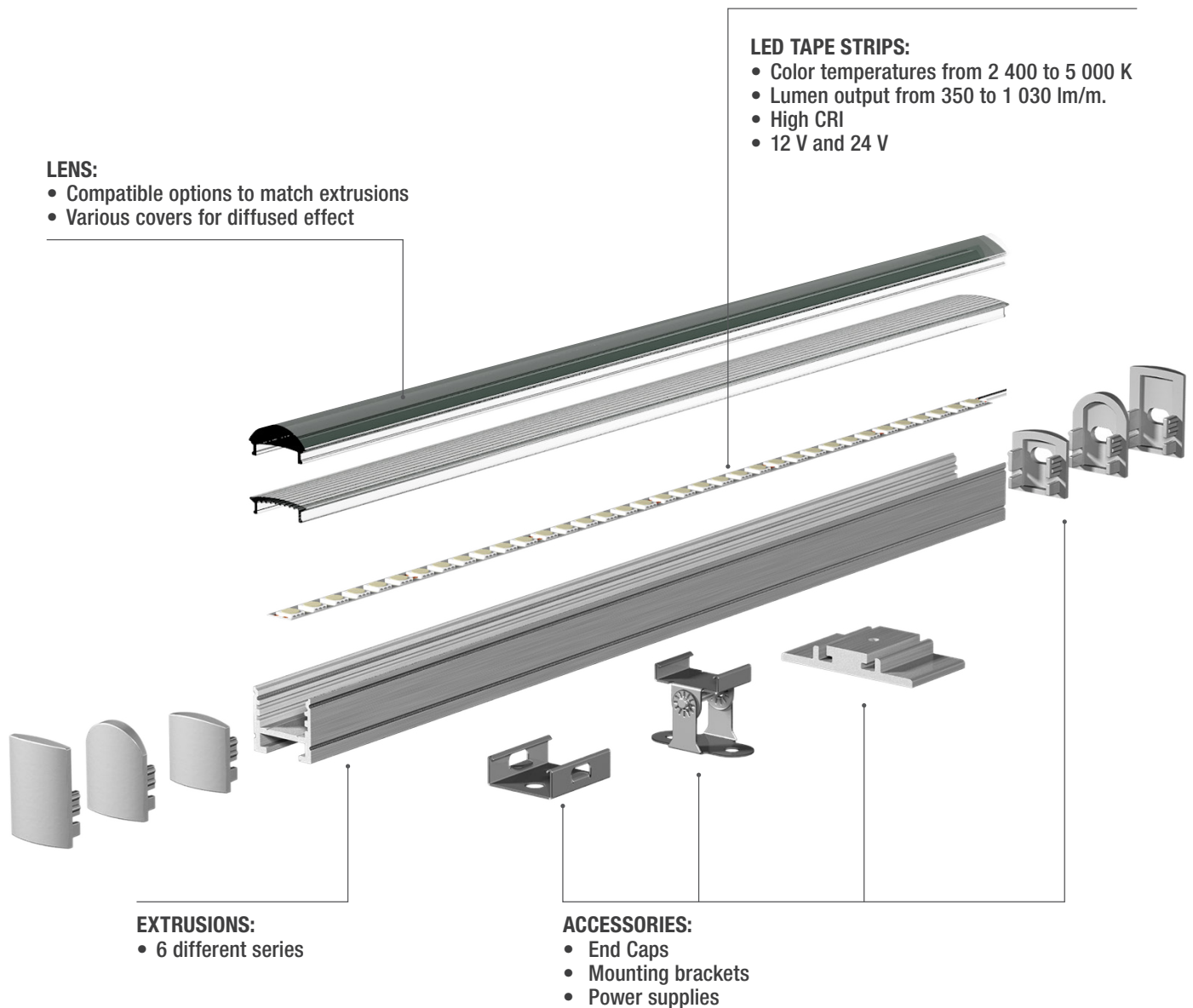



# LED CONFIGURATOR

Every lighting project may be planned quickly and easily with the help of the LED Configurator. This handy online tool will help guide with the corresponding and compatible components required to complete your lighting project: mounting options, accessories, and power supplies with a step-by-step process. A complete summary with all the necessary components and dimensions will be included along with the bill of material for immediate download.

Plan lighting projects with ease and efficiency using our user-friendly step-by-step guide. Create a personalized solution tailored to your specific needs! With Stanpro's [LED Configurator](#).



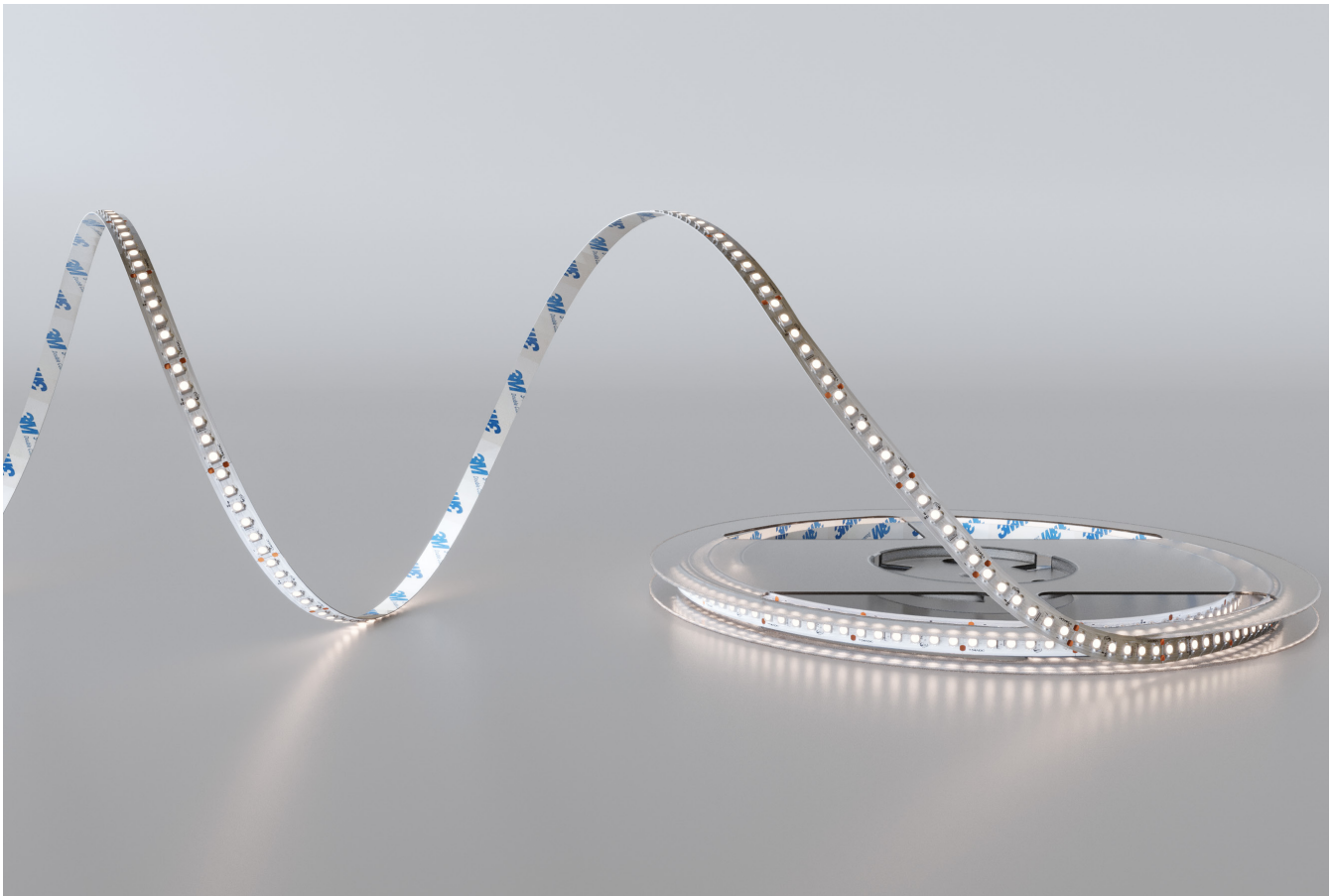

# LOW VOLTAGE LED TAPES

Stanpro's LED strips offer an extremely wide range of possible applications whether for general or accent lighting and for modest to large lighting projects. These flexible LED strips are long-lasting and energy-efficient. Also offered with an utmost flexibility in terms of quick ship ordering, with either 5M or 20M reels and individually custom cut solutions.

## LV LED Tapes offering:

- 1.5 W, 12 V and 24 V - IP22
- 2.9 W, 24 V - IP22
- 4.4 W, 24 V - IP22
- 2.9 W, 24 V - IP67
- RGB 4.4 W, 24 V - IP22

## OUR STANDARD COLOR TEMPERATURES (CCT)

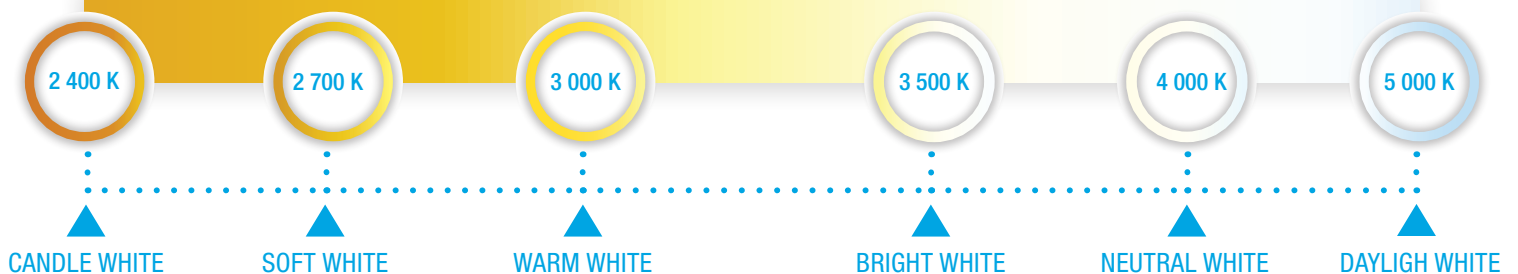

# LOW VOLTAGE LED TAPES SERIES GUIDE

## LED TAPES

## APPLICATION

12 V 24 V	1.5 W/ft. 110 lm	3 000 K 4 000 K	<b>LOW TO MEDIUM LIGHT OUTPUT</b> <ul style="list-style-type: none"> <li>• Under Cabinet</li> <li>• Cove</li> </ul>
24 V	2.9 W/ft. 180 - 230 lm	2 400 K 2 700 K 3 000 K 4 000 K 5 000 K	<b>LOW TO MEDIUM LIGHT OUTPUT</b> <ul style="list-style-type: none"> <li>• Under Cabinet</li> <li>• Cove</li> <li>• Wall Grazing</li> <li>• Displays</li> <li>• Retail</li> </ul>
24 V	4.4 W/ft. 300 lm	3 000 K 4 000 K	<b>HIGH OUTPUT LIGHT / HIGHER LUMENS</b> <ul style="list-style-type: none"> <li>• Cove</li> <li>• Dark Surfaces</li> <li>• Under Cabinet</li> <li>• Accent</li> <li>• Back Lighting</li> <li>• Entertainment</li> </ul>
RGB	4.4 W/ft. 170 lm	RGB	<ul style="list-style-type: none"> <li>• Entertainment</li> </ul>
IP67	2.9 W/ft. 180 - 230 lm	3 000 K 4 000 K	<b>DAMP OR WET LOCATIONS</b> <ul style="list-style-type: none"> <li>• Cove</li> <li>• Accent</li> <li>• Back Lighting</li> <li>• Wall Grazing</li> </ul>

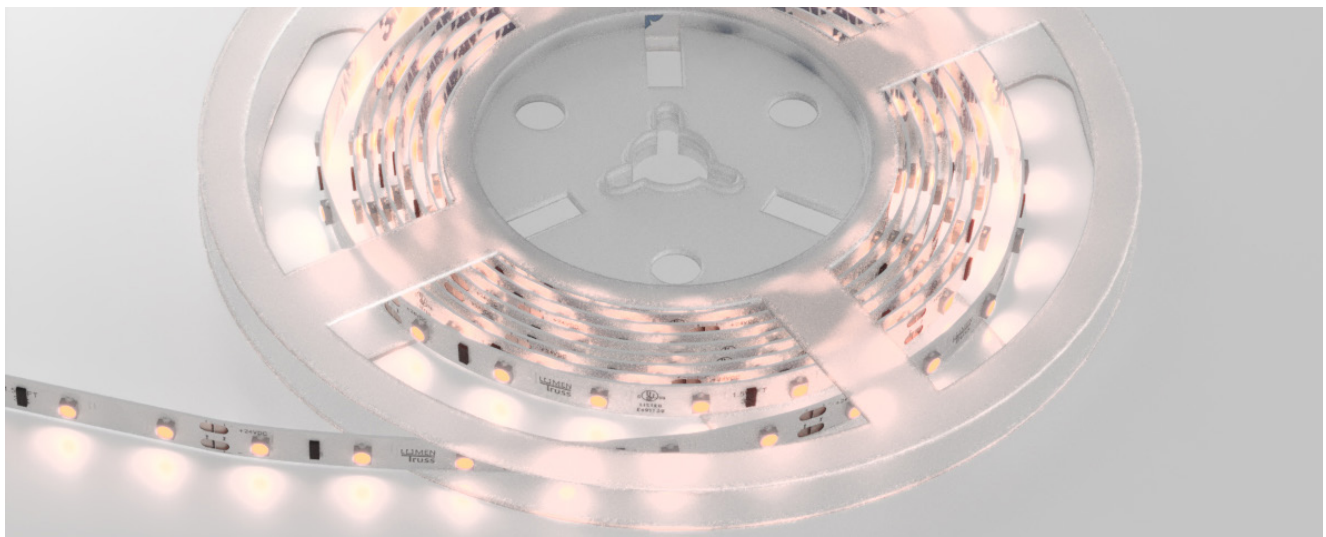



# LOW VOLTAGE LED TAPES

## 1.5W, 12 V AND 24 V - IP22

Stanpro's Low Voltage LED Tapes allows for complete flexibility in any project. Surfaced or recessed, they can be mounted on their own or installed into our aluminum extrusions for a suspended, surfaced, or recessed look.

- 18.3 LED/ft, 60 LED/m, 300 LED/reel
- 12 V can be cut every 2" (3 LEDs)
- 24 V can be cut every 4" (6 LEDs)
- Total reel wattage 24 W
- Color temperatures: 3 000, 4 000 K
- Do it yourself connectors available
- Custom lengths available

12 V - 1.5 W/ft. (4.8 W/m)

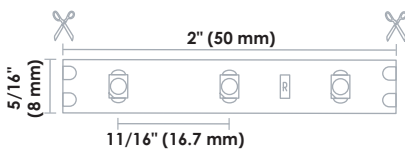

24 V - 1.5 W/ft. (4.8 W/m)



Order code	Model number	Watts (W)		Volts (V DC)	Color temp. (K)	Lumen output (lm)		Efficacy (lm/W)	CRI	Life L70 (hrs)	Power factor	Master case qty
		(per ft.)	(per m.)			(per ft.)	(per m.)					
<b>REEL 12 V - 16.4' (5 m)</b>												
65895	TAPE/16.4'/1.5W/30K/12 V/IP22/60/8MM/STD	1.5	4.8	12	3 000	110	360	75	90+	50 000	>0.9	25
65880	TAPE/16.4'/1.5W/40K/12 V/IP22/60/8MM/STD	1.5	4.8	12	4 000	123	405	84	90+	50 000	>0.9	25
<b>REEL 24 V - 16.4' (5 m)</b>												
65881	TAPE/16.4'/1.5W/30K/24 V/IP22/60/8MM/STD	1.5	4.8	24	3 000	107	350	73	90+	50 000	>0.9	25
65882	TAPE/16.4'/1.5W/40K/24 V/IP22/60/8MM/STD	1.5	4.8	24	4 000	109	356	74	90+	50 000	>0.9	25

## ORDERING GUIDE - Custom cut options

TP		LM1			D		
Series	Length	Lumens	Volts (V DC)	Color temp. (K)	Usage	WIRE FEED	
						Lead In	Lead Out
TP	Custom length up to 192" (16')	LM1 - 110lm/1.5W/90+	A - 12 V B - 24 V	30K - 3 000K 40K - 4 000K	D - IP22 indoor/dry	HW3 - Hardwire 3' HW6 - Hardwire 6' HW9 - Hardwire 9' HWX - Hardwire custom ft. FC3 - Female DC 3' FC6 - Female DC 6' FC9 - Female DC 9' FCX - Female DC custom ft. NL - No lead	HW3 - Hardwire 3' HW6 - Hardwire 6' HW9 - Hardwire 9' HWX - Hardwire custom ft. MC3 - Male DC 3' MC6 - Male DC 6' MC9 - Male DC 9' MCX - Male DC custom ft. NL - No lead





# LOW VOLTAGE LED TAPES

## 2.9 W, 24 V - IP22

Stanpro's Low Voltage LED Tapes allow the customization of any area, combining style and technology with reliability. This professional-grade flexible LED tape is ideal for installations that require a high degree of quality, a broad variety of key features, and limitless application possibilities such as stairways, cabinetry, coves, shelving, and linear decorative lighting.

- Reel 16.4' (5 m) : 36.6 LED/ft, 120 LED/m, 600 LED/reel
- Reel 65.6' (20 m): 36.6 LED/ft, 120 LED/m, 2 400 LED/reel
- Can be cut every 2" (6 LED)
- Total reel wattage 48 W - 192 W
- Do it yourself connectors available
- Custom lengths available
- Color temperatures: 2 400, 2 700, 3 000, 3 500, 4 000, 5 000 K

24 V - 2.9 W/ft. (9.6 W/m)

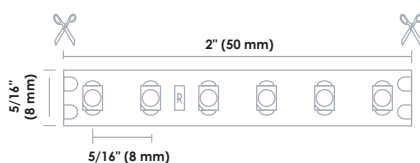

Order code	Model number	Watts		Volts (V DC)	Color temp. (K)	Lumen output (lm)		Efficacy (lm/W)	CRI	Life L70 (hrs)	Power factor	Master case qty
		(per ft.)	(per m.)			(per ft.)	(per m.)					
<b>REEL 16.4' (5 m)</b>												
65883	TAPE/16.4'/2.9W/24K/24 V/IP22/120/8MM/STD	2.9	9.6	24	2 400	172	566	76	90+	50 000	>0.9	25
65884	TAPE/16.4'/2.9W/27K/24 V/IP22/120/8MM/STD	2.9	9.6	24	2 700	191	625	65	90+	50 000	>0.9	25
65885	TAPE/16.4'/2.9W/30K/24 V/IP22/120/8MM/STD	2.9	9.6	24	3 000	194	635	66	90+	50 000	>0.9	25
65886	TAPE/16.4'/2.9W/35K/24 V/IP22/120/8MM/STD	2.9	9.6	24	3 500	204	670	70	90+	50 000	>0.9	25
65887	TAPE/16.4'/2.9W/40K/24 V/IP22/120/8MM/STD	2.9	9.6	24	4 000	226	740	77	90+	50 000	>0.9	25
65888	TAPE/16.4'/2.9W/50K/24 V/IP22/120/8MM/STD	2.9	9.6	24	5 000	228	749	78	90+	50 000	>0.9	25
<b>REEL 65.6' (20 m)</b>												
65891	TAPE/65.6'/2.9W/30K/24 V/IP22/120/8MM/STD	2.9	9.6	24	3 000	194	635	66	90+	50 000	>0.9	25
65892	TAPE/65.6'/2.9W/40K/24 V/IP22/120/8MM/STD	2.9	9.6	24	4 000	226	740	77	90+	50 000	>0.9	25

### ORDERING GUIDE - Custom cut options

TP	LM2	B	D	WIRE FEED			
Series	Length	Lumens	Volts (V DC)	Color temp. (K)	Usage	Lead In	Lead Out
TP	Custom length up to 192" (16')	LM2 - 255lm/2.9W/90+	B - 24 V	24K - 2 400K 27K - 2 700K 30K - 3 000K 35K - 3 500K 40K - 4 000K 50K - 5 000K	D - IP22 indoor/dry	<b>HW3</b> - Hardwire 3' <b>HW6</b> - Hardwire 6' <b>HW9</b> - Hardwire 9' <b>HWX</b> - Hardwire custom ft. <b>FC3</b> - Female DC 3' <b>FC6</b> - Female DC 6' <b>FC9</b> - Female DC 9' <b>FCX</b> - Female DC custom ft. <b>NL</b> - No lead	<b>HW3</b> - Hardwire 3' <b>HW6</b> - Hardwire 6' <b>HW9</b> - Hardwire 9' <b>HWX</b> - Hardwire custom ft. <b>MC3</b> - Male DC 3' <b>MC6</b> - Male DC 6' <b>MC9</b> - Male DC 9' <b>MCX</b> - Male DC custom ft. <b>NL</b> - No lead





# LOW VOLTAGE LED TAPES

## 4.4 W, 24 V - IP22

Stanpro's Low Voltage LED Tapes provide a reliable and flexible solution that is ideal for customizing any space. Allows for optimal lighting and offers complete flexibility to any project. Simple to install on its own or into Stanpro's aluminum extrusions with limitless application possibilities, bringing dream lighting looks to life with perfection.

- 54.9 LED/ft, 180 LED/m, 900 LED/reel
- Can be cut every 1 5/16" (6 LED)
- Total reel wattage 73 W
- Do it yourself connectors available
- Custom lengths available
- Color temperatures : 3 000 and 4 000 K

**24 V - 4.4 W/ft. (14.5 W/m)**

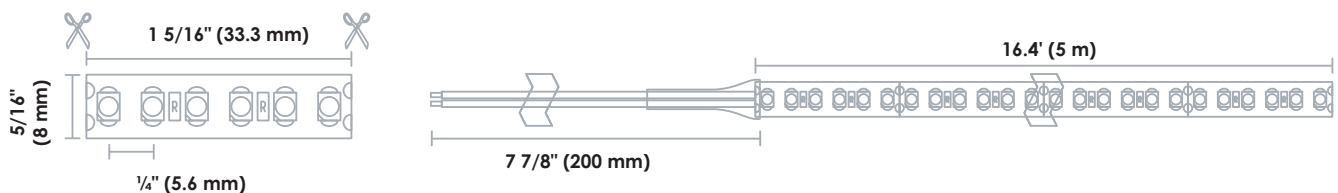



Order code	Model number	Watts		Volts (V DC)	Color temp. (K)	Lumen output (lm)		Efficacy (lm/W)	CRI	Life L70 (hrs)	Power factor	Master case qty
		(per ft.)	(per m.)			(per ft.)	(per m.)					

### Reel 16.4' (5m)

65889	TAPE/16.4'/4.4W/30K/24 V/IP22/180/8MM/STD	4.4	14.5	24	3 000	300	984	68	90+	50 000	>0.9	25
65890	TAPE/16.4'/4.4W/40K/24 V/IP22/180/8MM/STD	4.4	14.5	24	4 000	314	1 030	71	90+	50 000	>0.9	25

### ORDERING GUIDE - Custom cut options

TP		LM3	B		D		
Series	Length	Lumens	Volts (V DC)	Color temp. (K)	Usage	WIRE FEED	
						Lead In	Lead Out
TP	Custom length up to 192" (16')	LM3 - 300lm/4.4W/90+	B - 24 V	30K - 3 000K 40K - 4 000K	D - IP22 indoor/dry	HW3 - Hardwire 3' HW6 - Hardwire 6' HW9 - Hardwire 9' HWX - Hardwire custom ft. FC3 - Female DC 3' FC6 - Female DC 6' FC9 - Female DC 9' FCX - Female DC custom ft. NL - No lead	HW3 - Hardwire 3' HW6 - Hardwire 6' HW9 - Hardwire 9' HWX - Hardwire custom ft. MC3 - Male DC 3' MC6 - Male DC 6' MC9 - Male DC 9' MCX - Male DC custom ft. NL - No lead

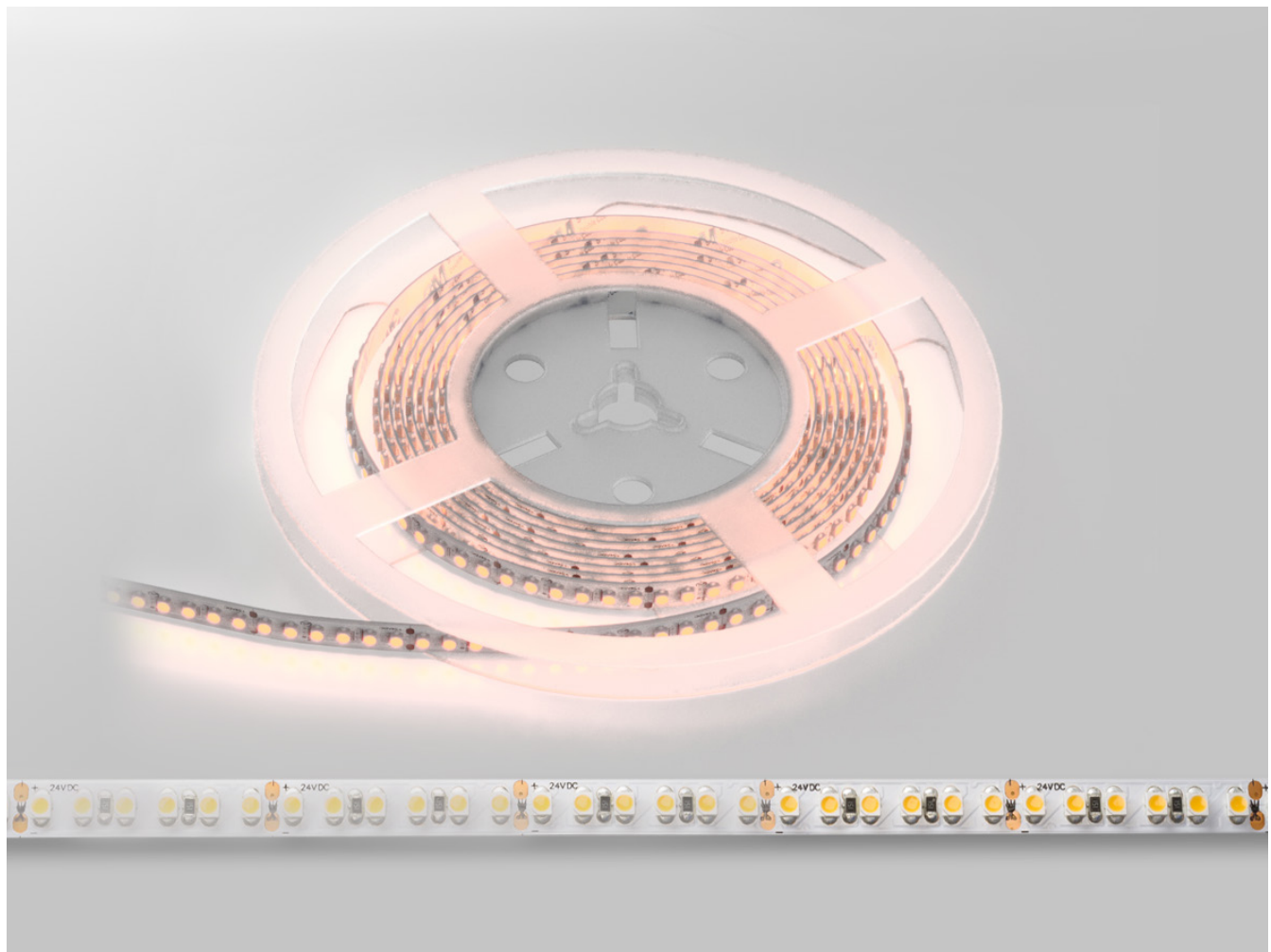



# LOW VOLTAGE LED TAPES

## WET LOCATION 2.9 W, 24 V - IP67

For applications that require protection from water exposure and humid conditions, Stanpro's Low Voltage IP67 LED Tape is encased in a clear PVC jacket. Simple and easy to install, simply mount in the desired location, connect to one of our LED power supplies, and light! Color rendering that is vivid and bright, with a CRI greater than 90.

- 36.6 LED/ft, 120 LED/m, 600 LED/reel
- Field cuttable
- Can be cut every 2" (6 LED)
- Total reel wattage 48 W
- Color temperatures : 3 000 and 4 000 K
- Easy to use wet location connectors.
- Fully encased IP67 - suitable for use in wet locations

24 V - 2.9 W/FT. (9.6 W/M)

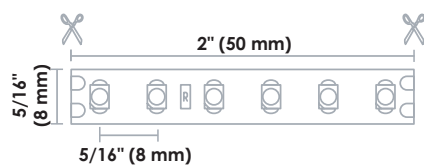

Order code	Model number	Watts		Volts (V DC)	Color temp. (K)	Lumen output (lm)		Efficacy (lm/W)	CRI	Life L70 (hrs)	Power factor	Master case qty
		(per ft.)	(per m.)			(per ft.)	(per m.)					
<b>REEL 16.4' (5 m)</b>												
65893	TAPE/16.4'/2.9W/30K/24 V/IP67/120/8MM/STD	2.9	9.6	24	3 000	186	609	63	90+	50 000	>0.9	25
65894	TAPE/16.4'/2.9W/40K/24 V/IP67/120/8MM/STD	2.9	9.6	24	4 000	213	697	73	90+	50 000	>0.9	25

### INCLUDED IN THE BOX



Endcaps



Clips



Silicone

### CONNECTORS & ACCESSORIES



A



B



C



D



E



F



G

Order code	Model Number	Type	Figure	Qty per pack	Case qty (master)
66134 <sup>1</sup>	TAPE/8MM/SINGLE_END_CONN/IP67/STD	Tape to Wire (8 mm - IP67)	A	10	300
66135	TAPE/8MM/IN_LINE_CONN/IP67/STD	Tape to Tape (8 mm - IP67)	A	10	300
66771 <sup>2</sup>	TAPE/2WAY_WIRE_TO_WIRE_CONN/STD	Two way - Wire to Wire	B	1	100
66242 <sup>2</sup>	TAPE/5WAY_WIRE_TO_WIRE_CONN/STD	Five way - Wire to Wire	C	5	200
66240	TAPE/WIRE_TO_DC_FEMALE/STD	Wire to DC Female	D	1	50
66241	TAPE/WIRE_TO_DC_MALE/STD	Wire to DC Male	E	1	50
66243	TAPE/DOUBLE_FACE_33M/STD	Double face tape	F	1	10
69734	TAPE/1 TO 5 ENTRY_DC_SPLITTER_FEMALE	Five way wire to DC Female	G	1	250

<sup>1</sup> Compatible wire : 20-22 AWG TR64 type

<sup>2</sup> Compatible wire : 12-24 AWG

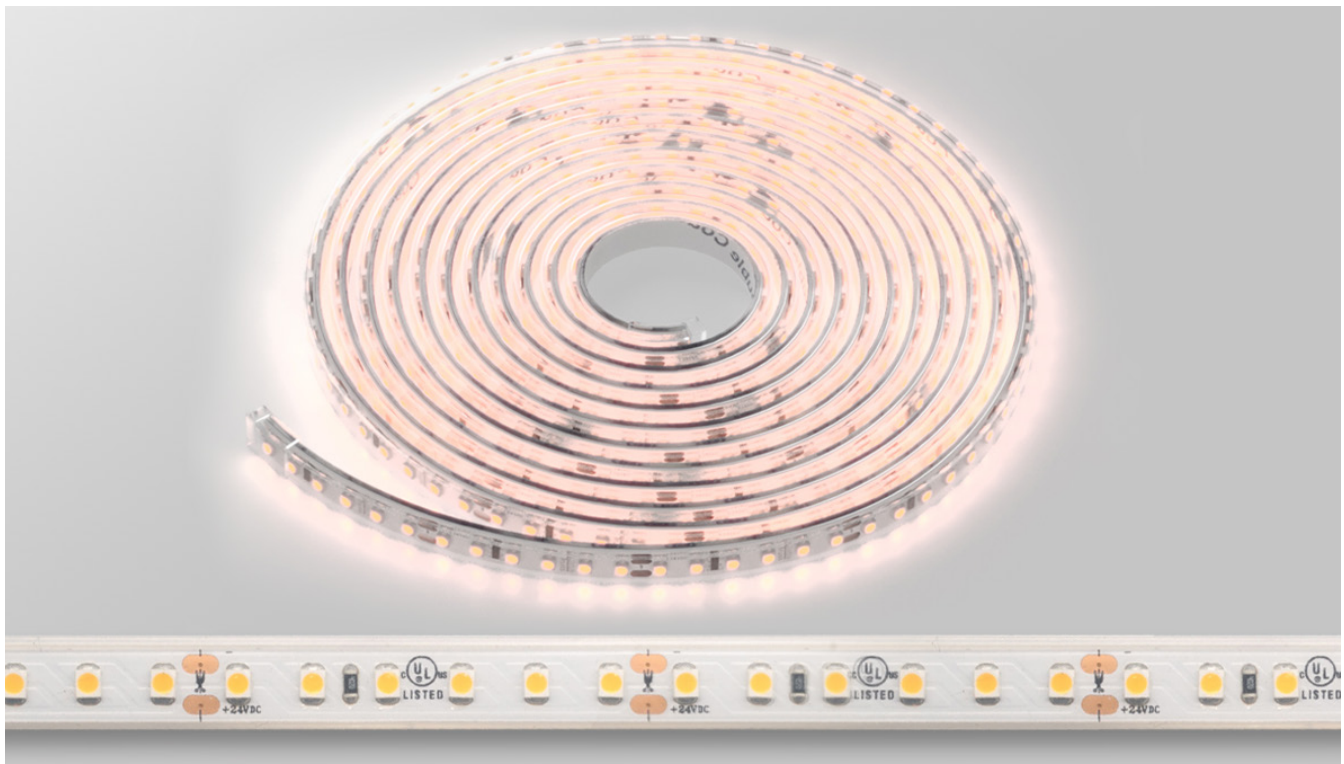



# LOW VOLTAGE LED TAPES

## RGB 4.4 W, 24 V - IP22

Stanpro's Low Voltage RGB LED Strip Tape is ideal to create a colored ambiance for any application. It allows to change the lighting design of an entire room with one simple click. The wireless remote control enables the selection of multiple modes, levels of brightness, the rhythms and the speed of colour changing.

- 18.3 LED/ft, 60 LED/m, 600 LED/reel
- Can be cut every 3 15/16" (6 LED)
- Total reel wattage 145 W
- Width: 10 mm (3/8")
- Slim low-voltage tape
- 3M Adhesive backing

### 24 V - 4.4 W/FT. (14.5 W/M)

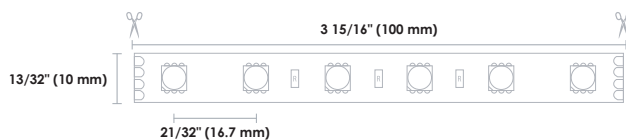

Order code	Model number	Watts		Volts (V DC)	Color temp. (K)	Lumen output (lm)		Efficacy (lm/W)	CRI	Life L70 (hrs)	Power factor	Max length (ft.)	Master case qty
		(W)	(per ft.)			(per m.)	(per ft.)						

### REEL 32.8' (10 m)

66838	TAPE/32.8'/4.4W/RGB/24 V/IP22/60/10MM/STD	4.4	14.5	24	RGB	170	558	38	90+	44 000	>0.9	18	25
-------	---	-----	------	----	-----	-----	-----	----	-----	--------	------	----	----



### LED RGB WIRELESS REMOTE AND CONTROLLER

Order code	Model number	Type	Controller maximum power <sup>1</sup> (W)	Output volts (V DC)	Master case qty
66840	TAPE/RGB/CONTROLLER-REMOTE/12 V-24 V/STD	Radio Frequency	100	12-24	50

<sup>1</sup> Industry suggests a max. load of 80%

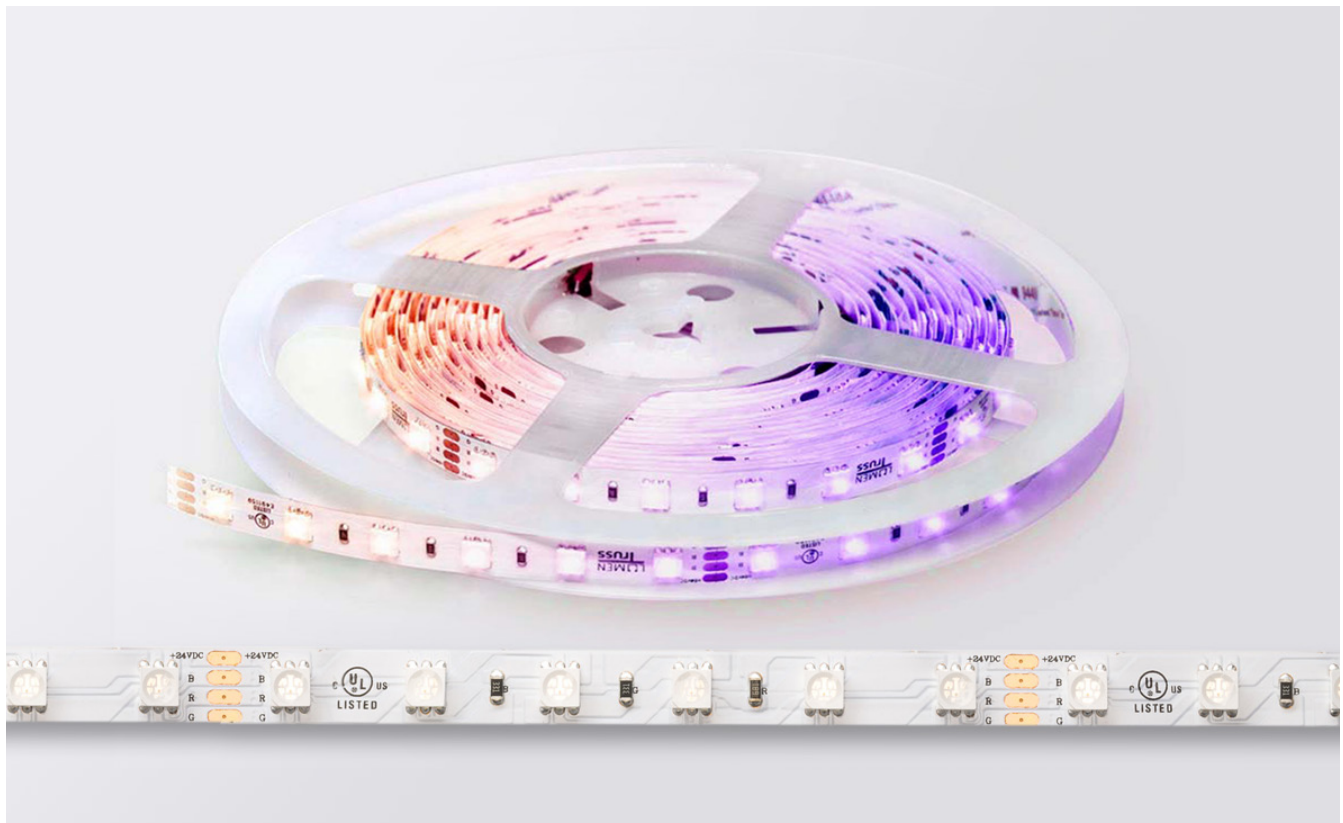



# EXTRUSIONS, LENSES & END CAPS

## MOUNTING ACCESSORIES

Stanpro's extrusions and lenses are used as channels for LED tape light. Our range of aluminum extrusions can be installed in various areas indoor or outdoor. Available in various shapes, they are combined with lenses to bring a modern touch in any lighting design application. The aluminum extrusion is designed to also work as a heatsink that helps manage heat dissipation of LED tapes.

- Made of ALCOA 6063 or 6163 T-5 aluminum alloy, increasing heat dissipation
- Clear, black, frosted, opal or diffused lens
- Mounting: Surfaced, suspended and recessed (into wall or ceiling, cabinet or millwork)
- Compatible with multiple installation accessories

66  
wet  
location

3  
warranty



# EXTRUSIONS

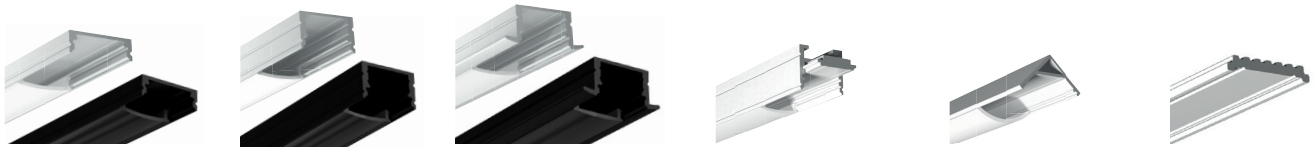

Series 100

Series 200

Series 210

Series 400

Series 500

Series 600

Order code	Model number	Series	Type	Finish / color	Length		Width		Height		Case qty (master)
					(ft.)	(m)	(in.)	(mm)	(in.)	(mm)	
65865	EXTRUSION/100/8'/ALUM/STD	100 <sup>1,2</sup>	Sleek	Silver	8	2.4	3/4	19	1/4	6	10
70110	EXTRUSION/100/8'/BLK	100 <sup>1,2</sup>	Sleek	Black	8	2.4	3/4	19	1/4	6	10
65866	EXTRUSION/200/8'/ALUM/STD	200 <sup>2</sup>	Deep	Silver	8	2.4	3/4	19	7/16	12	10
70111	EXTRUSION/200/8'/BLK	200 <sup>2</sup>	Deep	Black	8	2.4	3/4	19	7/16	12	10
65867	EXTRUSION/210/RECESSED/8'/ALUM/STD	210 <sup>2</sup>	Recessed	Silver	8	2.4	1 1/32	26	7/16	12	10
70112	EXTRUSION/210/8'/BLK	210 <sup>2</sup>	Recessed	Black	8	2.4	1 1/32	26	7/16	12	10
65868	EXTRUSION/400/8'/ALUM/STD	400 <sup>2</sup>	Versatile	Silver	8	2.4	3/4	19	21/32	17	10
65870	EXTRUSION/500/CORNER/8'/ALUM/STD	500 <sup>2</sup>	Corner	Silver	8	2.4	25/32	20	25/32	20	10
66678	EXTRUSION/600/8'/ALUM/STD	600 <sup>2</sup>	Heatsink	Silver	8	2.4	1/2	13	3/32	2	20

<sup>1</sup>The thickness of this extrusion does not allow to use Stanpro's connectors inside. Soldering is required when using this extrusion.

<sup>2</sup>To use with RGB and IP67 LV LED tapes, soldering is required due to the thickness which does not allow the use of Stanpro's connectors inside.

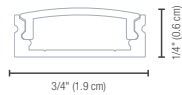

Series 100 with lens

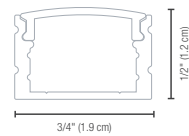

Series 200 with lens

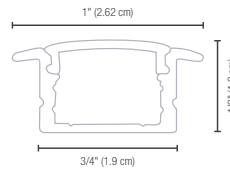

Series 210 with lens

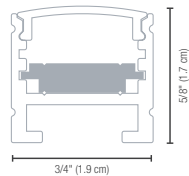

Series 400 with lens

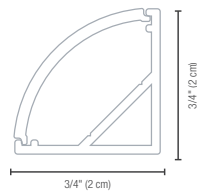

Series 500 with lens

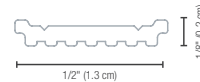

Series 600



# LENSES

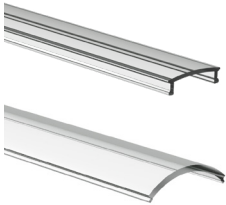
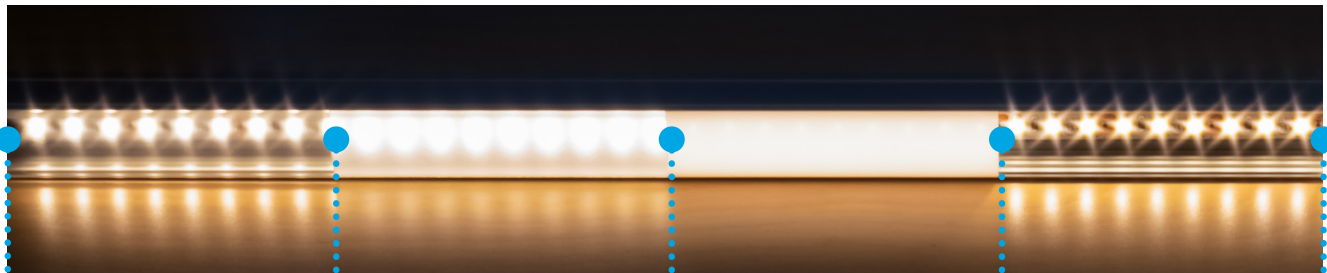

## CLEAR

Lens is designed to maximize the light output

- 98% light output



## FROSTED

Reduce glare and create a soft, diffused light for an even, clean light distribution.

- 85% light output
- Softer light

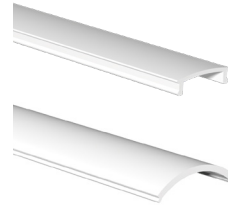

## OPAL

Dot free and invisible LEDs. Best used with thin extrusions.

- 65% light output
- Gentle diffusion and homogeneous (uniform) light



## DIFFUSED

LEDs are partly visible, creating ambient lighting for surrounding objects.

- 95% light output
- Wider beam angle



## BLACK LENS

Stays in the dark when lights are off, for a subtle, clean and invisible statement.

- 74% light output

Order code	Model number	Type	Finish	Length		Width		Compatible with series	Case qty (master)
				(ft.)	(m)	(in.)	(mm)		
65871	LENS/8'/CLEAR/STD	Flat	Clear	8	2.4	23/32	18	100, 200, 210, 400	20
65872	LENS/8'/OPAL/STD	Flat	Opal	8	2.4	23/32	18	100, 200, 210, 400	20
65873	LENS/8'/FROSTED/STD	Flat	Frosted	8	2.4	23/32	18	100, 200, 210, 400	20
65874	LENS/8'/DIFFUSED/STD	Flat	Diffused	8	2.4	23/32	18	100, 200, 210, 400	20
65875	LENS/8'/ROUNDED/CLEAR/STD	Rounded	Clear	8	2.4	31/32	25	500	20
65876	LENS/8'/ROUNDED/FROSTED/STD	Rounded	Frosted	8	2.4	31/32	25	500	20
65877	LENS/8'/ROUNDED/OPAL/STD	Rounded	Opal	8	2.4	31/32	25	500	20
70118	LENS/8'/CLEAR/BLACK	Flat	Black	8	2.4	23/32	18	100, 200, 210	20



# END CAPS & ACCESSORIES

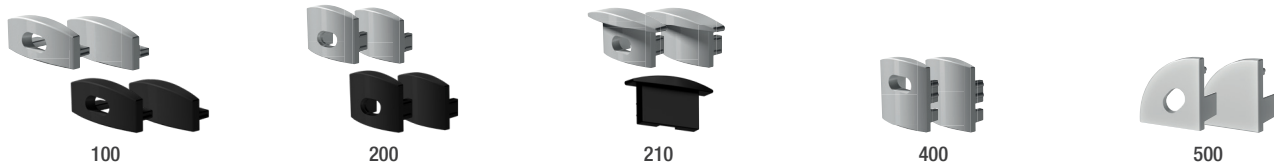

## END CAP (10 pack)

Order code	Description	Type	Color	Compatible with series	Case qty (master)
65896	EXTRUSION/100/ENDCAP/HOLE/STD	Perforated	Silver	100	50
65897	EXTRUSION/100/ENDCAP/PLAIN/STD	Plain	Silver	100	50
70113	EXTRUSION/100/ENDCAP/HOLE/BLK	Perforated	Black	100	50
70114	EXTRUSION/100/ENDCAP/PLAIN/BLK	Plain	Black	100	50
65898	EXTRUSION/200/ENDCAP/HOLE/STD	Perforated	Silver	200	50
65899	EXTRUSION/200/ENDCAP/PLAIN/STD	Plain	Silver	200	50
70115	EXTRUSION/200/ENDCAP/HOLE/BLK	Perforated	Black	200	50
70116	EXTRUSION/200/ENDCAP/PLAIN/BLK	Plain	Black	200	50
65900	EXTRUSION/210/ENDCAP/HOLE/STD	Perforated	Silver	210	50
65901	EXTRUSION/210/ENDCAP/PLAIN/STD	Plain	Silver	210	50
70117	EXTRUSION/210/ENDCAP/BLK	Perforated <sup>1</sup>	Black	210	50
65902	EXTRUSION/400/ENDCAP/HOLE/STD	Perforated	Silver	400	50
65903	EXTRUSION/400/ENDCAP/PLAIN/STD	Plain	Silver	400	50
65906	EXTRUSION/500R/ENDCAP/HOLE/STD	Perforated	Silver	500	50
65907	EXTRUSION/500R/ENDCAP/PLAIN/STD	Plain	Silver	500	50

<sup>1</sup>Perforated at the bottom to allow easy passage of wiring.

## ACCESSORIES

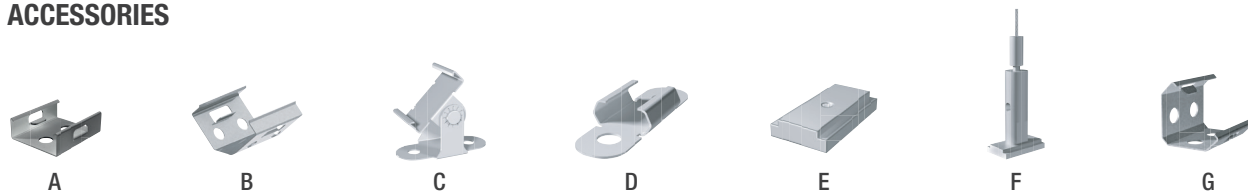

## FIXING CLIP (2 pack)

Order code	Model number	Type	Figure	Compatible with series	Case qty (master)
65908	EXTRUSION/FIXCLIP/180/STD 2P	180°	A	100, 200, 210, 400	100
65909	EXTRUSION/FIXCLIP/45/STD 2P	45°	B	100, 200, 400	100
65910	EXTRUSION/FIXCLIP/ADJ/STD 2P	Adjustable	C	100, 200, 400	100
65911	EXTRUSION/FIXCLIP/INV/STD 2P	Invisible	D	400	100
65913	EXTRUSION/MAGNET/STD 2P	Magnet	E	400	100
65912	EXTRUSION/SUSPENSIONKIT/STD	Suspension Kit (single pack)	F	400	50
65914	EXTRUSION/FIXCLIP/500/CORNER/STD 2P	For corner	G	500	100



# CONNECTORS, WIRES & ACCESSORIES

## COMPONENTS FOR LED TAPE SYSTEMS IP22

Stanpro supplies a wide range of accessories to complete and customize each LOW VOLTAGE TAPE SYSTEM. A wide variety of connectors, extensions, splitters, wire leads are in this section to make installation a breeze!

- No soldering required
- Easy do it yourself installation
- Can accommodate various configurations
- Quick and secure connections
- Suitable for dry location

Compatible with Stanpro's IP22 Low Voltage LED tape



## CONNECTORS & ACCESSORIES

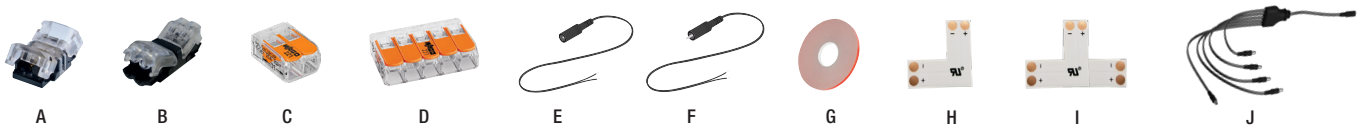

Order code	Model number	Description	Figure	Dimensions	Compatible	Colour	Certification	Qty per pack	Case qty (master)
66130	TAPE/8MM/SINGLE_END_CONN/STD	Tape to Wire (8 mm)	A	2 m. wire (incl.)	20-22 AWG TR64 type	Clear / Black	RoHS	10	300
66132	TAPE/8MM/IN_LINE_CONN/STD	Tape to Tape (8mm)	A	-	LV LED Tapes (8mm)	Clear / Black	RoHS	10	300
66239	TAPE/WIRE_TO_WIRE_CONN/STD	Wire to Wire (8mm)	B	-	20-22 AWG TR64 type	Clear / Black	-	10	300
66771	TAPE/2WAY_WIRE_TO_WIRE_CONN/STD	Two way - Wire to Wire	C	11.2 x 13.1 x 8.3 mm	12-24 AWG	Orange	-	1	100
66242	TAPE/5WAY_WIRE_TO_WIRE_CONN/STD 4P	Five way - Wire to Wire	D	18.6 x 29.9 x 8.3 mm	12-24 AWG	Orange	-	5	200
66240	TAPE/WIRE_TO_DC_FEMALE/STD	Wire to DC Female	E	12"	20 AWG	Black	-	1	50
66241	TAPE/WIRE_TO_DC_MALE/STD	Wire to DC Male	F	12"	20 AWG	Black	-	1	50
66243	TAPE/DOUBLE_FACE_33M/STD	Double face tape	G	33 m	-	Red	-	1	10
67630	TAPE/8MM/LSHAPECORNER/STD 5P	L Shape PCB Joiner	H	20 x 8 mm	-	White	RU	1	250
67631	TAPE/8MM/TSHAPECORNER/STD 5P	T Shape PCB Joiner	I	32 x 20x 8 mm	-	White	RU	1	250
69734	TAPE/1 TO 5 ENTRY_DC_SPLITTER_FEMALE	Five way wire to DC Female	J	11 x 11 x 400 mm	-	Black	-	1	250



## DIAGRAMS

66130 - TAPE TO WIRE

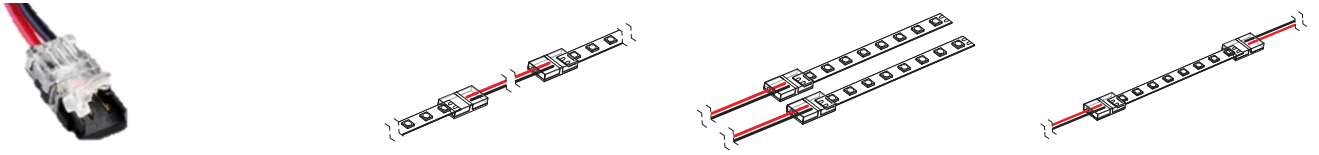

66132 - TAPE TO TAPE



66239 - WIRE TO WIRE



# DIAGRAMS

66242 - FIVE-WAY WAGOS

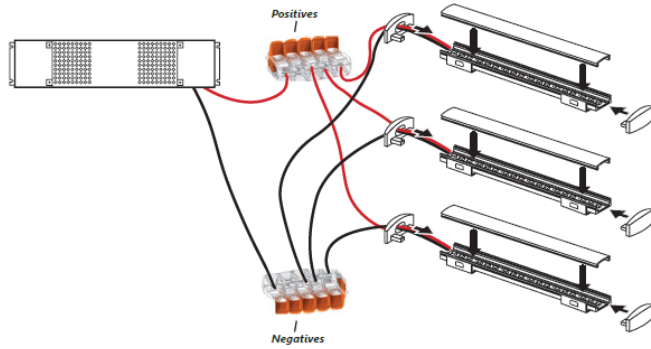

66771 - TWO WAY WAGOS

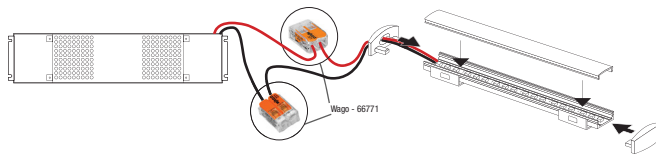

66240 - WIRE CONNECTORS

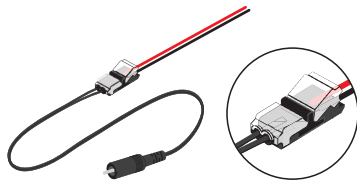
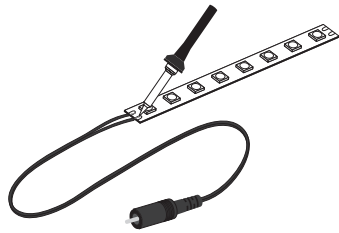
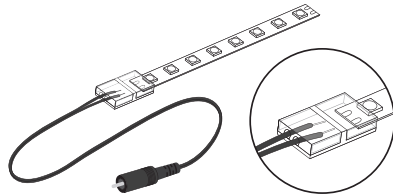

69734 - 1 TO 5 DC SPLITTER

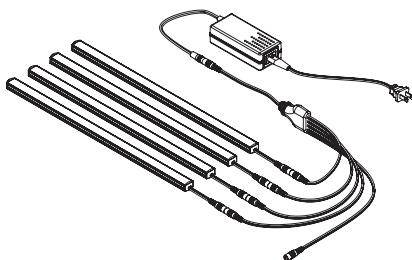

67630 - L SHAPE PCB JOINER

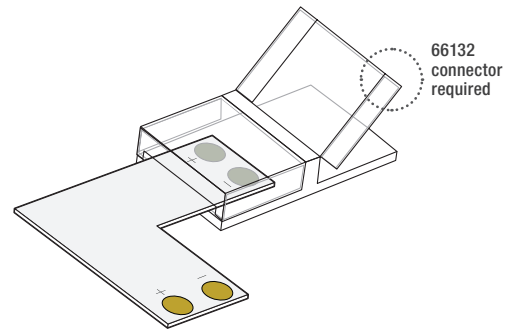
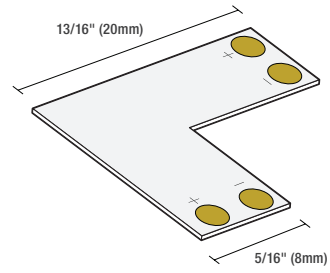

67631 - T SHAPE PCB JOINER

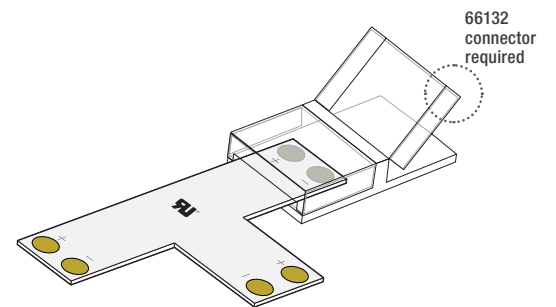
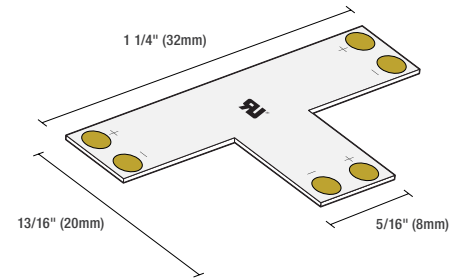





# LINE VOLTAGE TAPE SYSTEMS

## DRIVERLESS 120 V LED STRIPS & ACCESSORIES

This LED tape works on direct line voltage 120 V, no need for an additional driver to be added to the system. Its robust construction, PVC jacket as well as IP65 certification, makes it ideal for accent lighting in any retail, residential or commercial space, without any risk of voltage drop. Offered in 10, 30 or 50 meter reels, perfect for long runs.

Can be covered within an extrusion to enhance performance and durability with a variety of mounting brackets and accessories options that can be assembled in field for a complete custom solution.

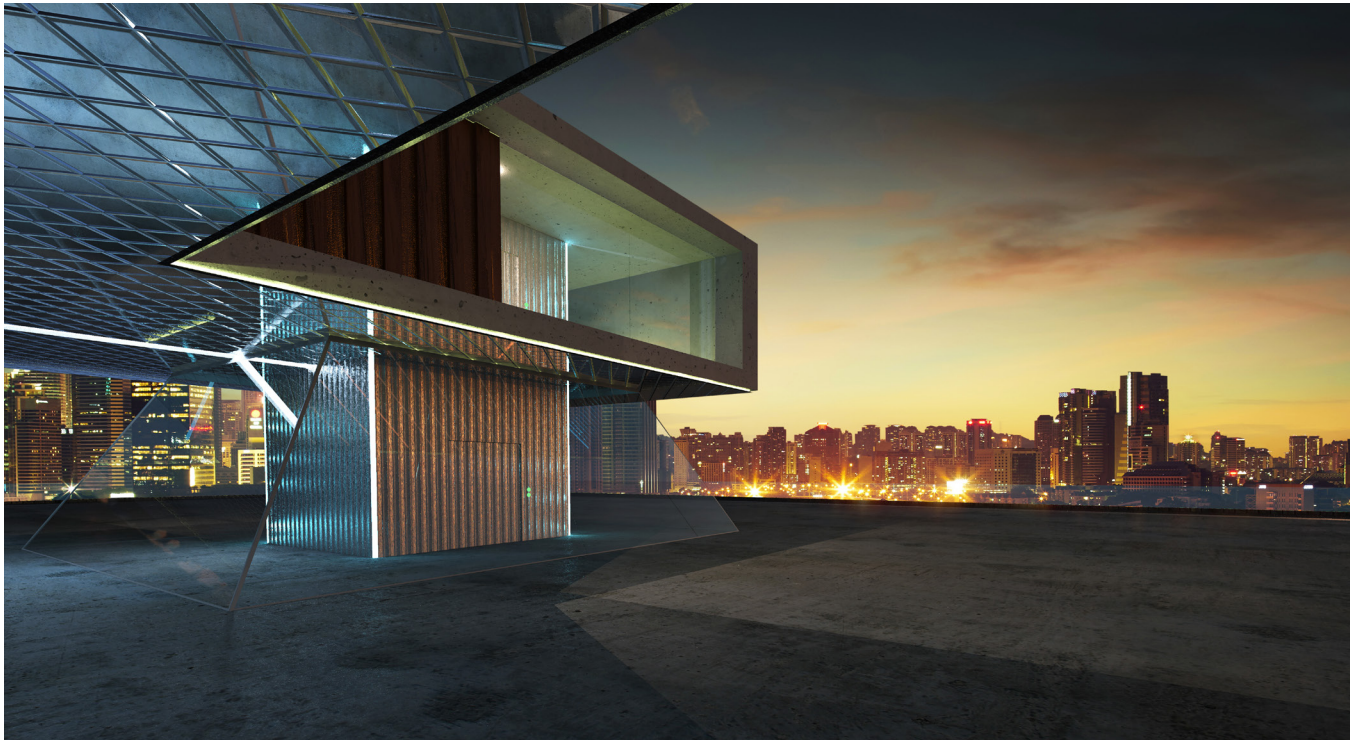

# LINE VOLTAGE TAPE

## DRIVERLESS 120 V LED STRIP

Stanpro's LINE VOLTAGE TAPE SYSTEM is simple and easy to install offering up to 164 feet of continuous linear light without the risk of voltage drop. The 120 V LED tape includes features such as a sealed clear PVC coating, warm white to daylight color temperatures and a multitude of accessories to accommodate any project. IP65 rated suitable for wet locations.

- Cuttable every 12" (1 ft.)
- Total reel wattage 132 W - 660 W
- High lumen efficiency
- No need for additional power (164 ft max. run)
- ETL listed for wet locations

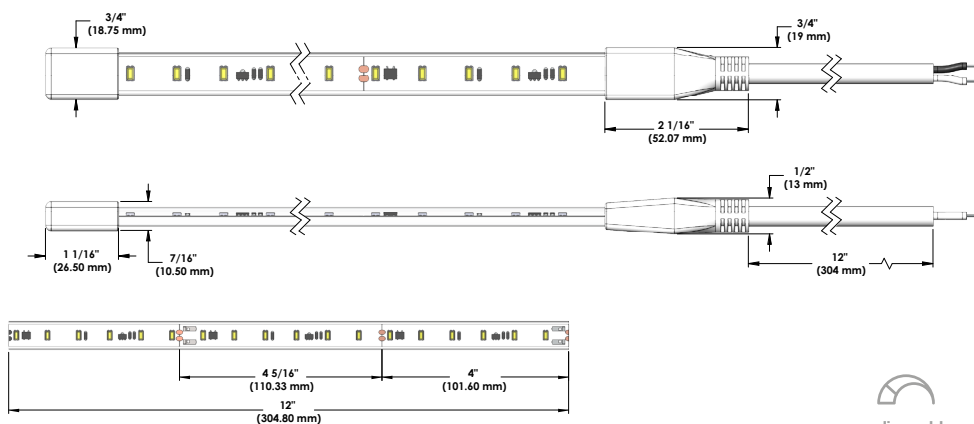



Order code	Model number	Watts		Volts (V AC)	Color temp. (K)	Lumen output (lm)		Efficacy (lm/W)	CRI	Life L70 (hrs)	Power factor	Master case qty
		(per ft.)	(per m.)			(per ft.)	(per m.)					
<b>REEL 32.8' (10 m)</b>												
67632	TAPE/32.8'/4W/27K/120V/IP65/72/16MM/STD	4	13.2	120	2 700	350	1 148	87	90+	50 000	>0.9	1
67635	TAPE/32.8'/4W/30K/120V/IP65/72/16MM/STD	4	13.2	120	3 000	350	1 148	87	90+	50 000	>0.9	1
67638	TAPE/32.8'/4W/40K/120V/IP65/72/16MM/STD	4	13.2	120	4 000	350	1 148	87	90+	50 000	>0.9	1
<b>REEL 98.4' (30 m)</b>												
67633	TAPE/98.4'/4W/27K/120V/IP65/72/16MM/STD	4	13.2	120	2 700	350	1 148	87	90+	50 000	>0.9	1
67636	TAPE/98.4'/4W/30K/120V/IP65/72/16MM/STD	4	13.2	120	3 000	350	1 148	87	90+	50 000	>0.9	1
67639	TAPE/98.4'/4W/40K/120V/IP65/72/16MM/STD	4	13.2	120	4 000	350	1 148	87	90+	50 000	>0.9	1
<b>REEL 164' (50 m)</b>												
67634	TAPE/164'/4W/27K/120V/IP65/72/16MM/STD	4	13.2	120	2 700	350	1 148	87	90+	50 000	>0.9	1
67637	TAPE/164'/4W/30K/120V/IP65/72/16MM/STD	4	13.2	120	3 000	350	1 148	87	90+	50 000	>0.9	1
67640	TAPE/164'/4W/40K/120V/IP65/72/16MM/STD	4	13.2	120	4 000	350	1 148	87	90+	50 000	>0.9	1

## CONNECTORS & ACCESSORIES

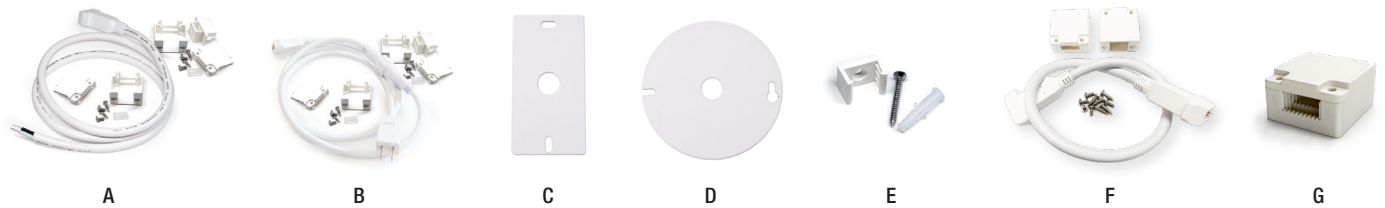

Order code	Description	Type	Figure	Qty per pack	Master case qty
67641 <sup>1</sup>	TAPE/HARDWIREKIT/120V/STD	Hardwire Kit (40" (1 000 mm))	A	1	50
67642 <sup>1</sup>	TAPE/PLUG/120V/STD	120 V Power Cord (44" 1/4 (1 132 mm))	B	1	50
67643	TAPE/ELECTBOXCOVER/RECT/120V/STD	Electrical box cover plate - Rectangular	C	1	100
67644	TAPE/ELECTBOXCOVER/RND/120V/STD	Electrical box cover plate - Round	D	1	100
67645 <sup>2</sup>	TAPE/BRACKETS/120V/STD 10P	Mounting bracket	E	10	100
67904	TAPE/6IN/JUMPER/120V/STD	6" Jumper	F	1	100
67905	TAPE/12IN/JUMPER/120V/STD	12" Jumper	F	1	100
69020	TAPE/HARDWARE/120V/ENDCAPS	End Cap	G	1	50

<sup>1</sup> Includes brackets and screws.

<sup>2</sup> It is recommended to put a fixing clip every 6" to ensure secure installation.





# EXTRUSION, LENS & ACCESSORIES

## MOUNTING ACCESSORIES FOR LINE VOLTAGE TAPE

The 120 V extrusion is specifically designed to accommodate Stanpro's Line Voltage LED tape. Featuring a high-efficiency reflector and a sliding lens delivering consistent lighting with a dot-free effect. An ideal solution for long linear runs for indoor or outdoor applications.

- Made of aluminum alloy (ALCOA 6063-T5) increases heat dissipation
- PVC reflector secures the 120 V tape in place and enhances light performance
- Prime lens for a dot free effect
- Surface mounting
- Continuous row mounting connector available
- Field cuttable

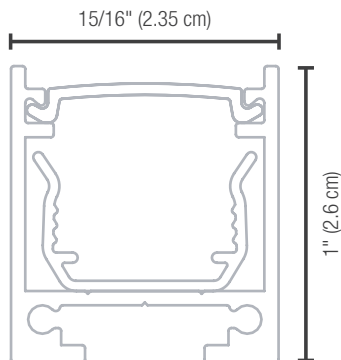

# EXTRUSION, LENS & ACCESSORIES

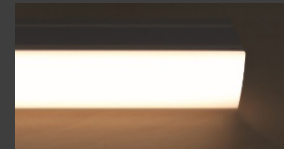

## PRIME LENS

Best combination of frosted and opal lenses

- 73% light output
- Optimal light transmittance
- Dot free effect

Order code	Model number	Series	Type	Finish / color	Length ft. (m)	Width in. (mm)	Height in. (mm)	Case qty (master)
<b>Extrusion</b>								
69858 <sup>1</sup>	EXTRUSION/4050/8/ALUM <sup>2</sup>	4050	Extra Deep	Silver	8 (2.4)	15/16 (23.5)	1 (26)	5
<b>Lens</b>								
69859	LENS/8/4050/PRIME	4050	Flat	Prime	8 (2.4)	7/8 (22)	1/8 (3.2)	20
<b>End caps</b>								
69860	ENDCAP/4050/ALUM	4050	Perforated	Silver	-	15/16 (23.5)	1 (26)	50

<sup>1</sup> Accommodates Stanpro's quick connectors to be installed inside the extrusion with LV LED tapes IP67 & RGB

<sup>2</sup> PVC reflector included with extrusion

## ACCESSORIES (order separately)



Order code	Model number	Type	Figure	Case qty (master)
65911	EXTRUSION/FIXCLIP/INV/STD 2P	Fixing Clips - Invisible	A	100
65913	EXTRUSION/MAGNET/STD 2P	Fixing Clips - Magnet	B	100
69861	EXTRUSION/4050/FIXCLIP/ADJ 2P	Fixing Clips - Adjustable	C	50
69864	EXTRUSION/4050/FIXCLIP/90 2P	Fixing Clips - 90°	D	50
69865	EXTRUSION/4050/FIXCLIP/45 2P	Fixing Clips - 45°	E	50
70123	JOINER/BRACKET/4050	Continuous row mount bracket (single pack)	F	50





# LED TAPE KITS

WARM WHITE,  
COOL WHITE OR RGB

EASY DIY KIT

Stanpro's Tape Kits are designed for easy, Do It Yourself projects and include all of the necessary installation components for a simple linear lighting systems. Installations are quick and simple since they eliminate guesswork and compatibility concerns. These convenient kits provide an easy way to adjust the atmosphere to any energy level with warm whites for relaxing, cool whites for focusing, and RGB to create millions of color possibilities!



# COB TAPE KIT

## EASY DIY

Stanpro's COB TAPE KIT includes all the components required to build a complete tape light system. Designed to eliminate visible LED chips, resulting in a spot and dot free effect to produce a warm and uniform glow. An excellent choice for installation in the most subtle areas illuminating borders, coves, cabinets, and closets. IP65 rated for use in damp or wet environments.

- 97 LED/ft, 320 LED/m, 1 600 LED/reel
- Can be cut every 2" (5 cm)
- Available in 3 000 K and 4 000 K
- Total reel wattage 27.5 W
- Width: 10 mm (3/8")

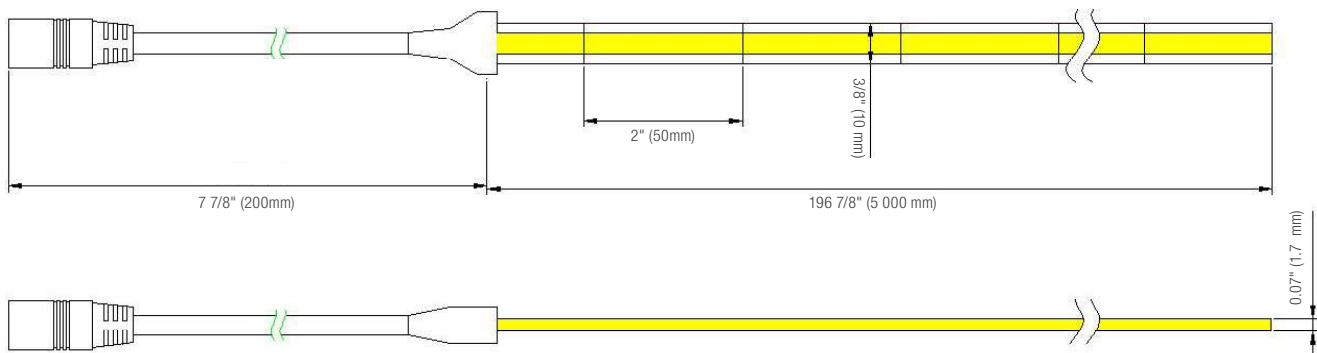

Order code	Model number	Watts		Volts (V DC)	Color temp. (K)	Lumen output (lm)		Efficacy (lm/W)	Beam angle (°)	Life L70 (hrs)	Dimming (Yes/No)	Number of LED chips		Master case qty
		(per ft.)	(per m.)			(per ft.)	(per m.)					(per ft.)	(per m.)	
<b>REEL 16.4' (5 m)</b>														
69445	COB/TAPE/KIT/16.4'/5.5W/30K/24V/10MM	1.7	5.5	24	3 000K	170	545	80	140	50 000	No	97	320	20
69446	COB/TAPE/KIT/16.4'/5.5W/40K/24V/10MM	1.7	5.5	24	4 000K	190	610	90	140	50 000	No	97	320	20

## INCLUDED IN THE BOX



1 Tape light 16.4' (5m)



1 Plug-in driver

## ACCESSORIES

Order code	Model number	Type	FIGURE (refer to pics)	Quantity per pack	Master case qty
69447	TAPE/COB/CONNECTOR	COB Connector	A	10	100
62017	LED/10PCS TAPE LIGHT MOUNTING CLIPS	Mounting clips	B	10	100



A



B





# LED TAPE KITS

## EASY DIY KIT - WARM WHITE, COOL WHITE OR RGB

Stanpro's low-voltage LED TAPE KITS are designed to enhance any space with a dramatic statement of color. Add ambiance and character to any setting. It provides great brightness either for color changing RGB version or cool and warm white colors and with its ease of installation, it can be used in a multitude of applications both indoor and outdoor!

- 9 LED/ft, 30 LED/m, 150 LED/reel
- RGB can be cut every 4" (3 LEDs)
- 2 700 & 5 000 K can be cut every 2" (3 LEDs)
- Total reel wattage 27 W
- Width: 10 mm (3/8")

61953

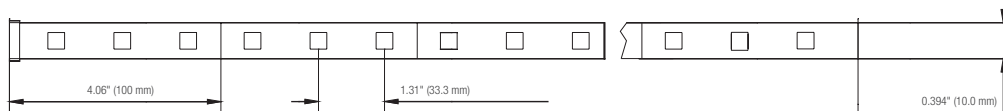

61954 - 61955

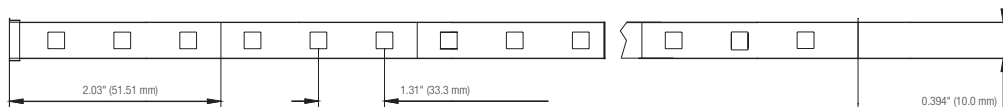



Order code	Model number	Watts		Volts (V DC)	Color temp. (K)	Lumen output (lm)		Life L70 (hrs)	Dimming capability (Yes/No)	Number of LED chips		Master case qty
		(per ft.)	(per m.)			(per ft.)	(per m.)			(per ft.)	(per m.)	
<b>REEL 16.4' (5 m)</b>												
61953	LED/TAPE/16.4'/5050/RGB KIT/12 V/50M/STD	1.6	5.4	12	RGB	-	-	30 000	Yes	9	30	20
61954	LED/TAPE/16.4'/5050/WW KIT/12 V/50M/STD	1.7	5.6	12	2 700	123	396	30 000	No	9	30	20
61955	LED/TAPE/16.4'/5050/CW KIT/12 V/50M/STD	1.7	5.6	12	5 000	123	396	30 000	No	9	30	20

## INCLUDED IN THE BOX



1 RGB remote control (for RGB kit only)



1 Plug-in driver



2 End caps



1 Tape light 16.4' (5m)

## ACCESSORIES

Order code	Description	Type	Figure refer to pics	Quantity per pack	Case qty (master)
61956	LED/TAPE/RGB/CONNECTOR/STD	RGB Connector	A	10	50
61957	LED/TAPE/WW+CW/CONNECTOR/STD	Connector	B	10	100
62017	LED/10PCS TAPE LIGHT 12 V MOUNTING CLIPS	Mounting clips	C	10	100

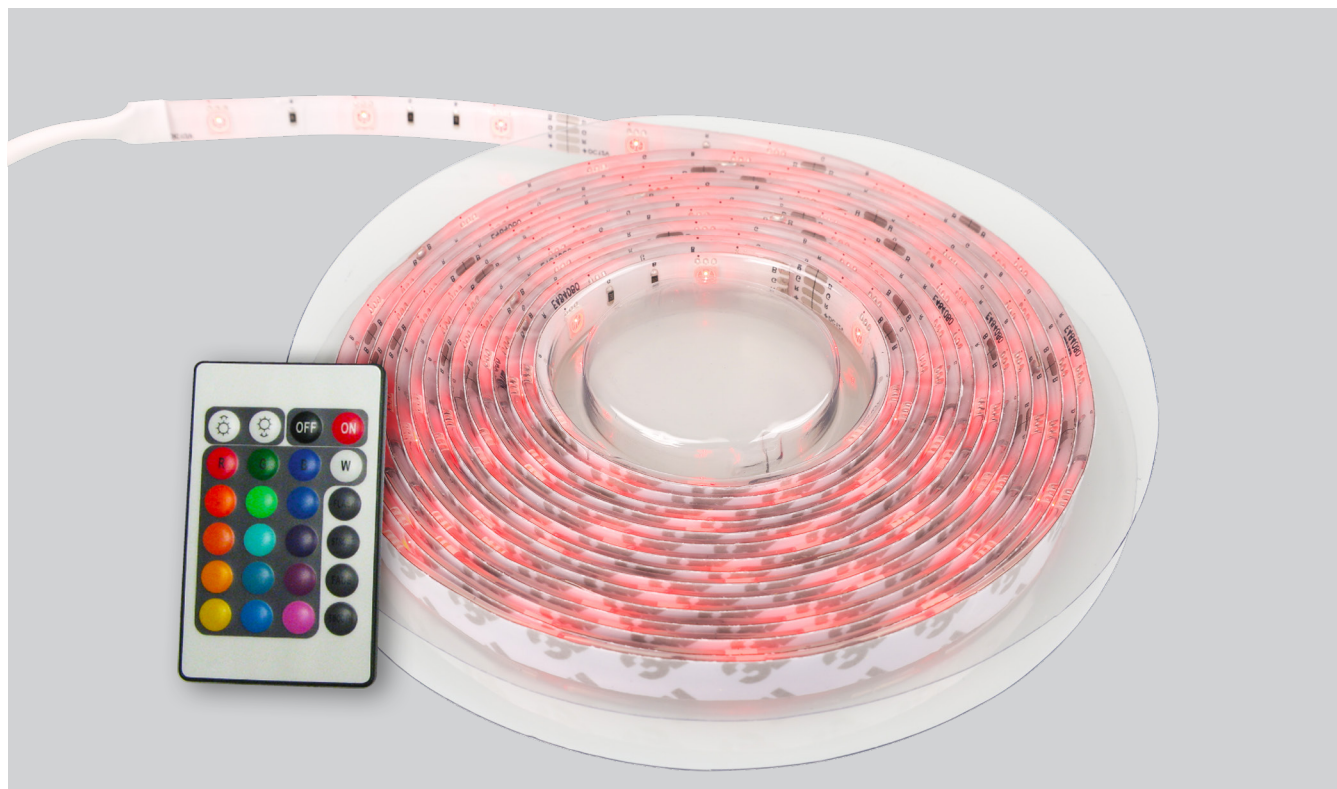
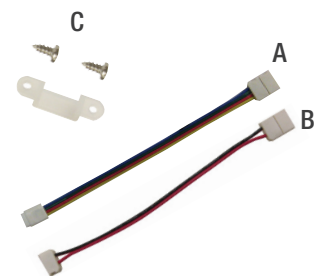





# POWER SUPPLIES

## LED DRIVERS 12 V & 24 V CLASS 2

Stanpro's constant voltage power supplies are available to support our LED tape systems and low-voltage undercabinet luminaires. They are available in various wattage options, dimming and connection types. Applicable for residential and commercial applications all models are offered in Class 2.

# LED DRIVERS 12 V & 24 V

## CLASS 2

- High efficiency of up to 88%
- TRIAC, Forward and reverse phase
- Flicker-free dimming
- Protections: short-circuit, over-voltage
- Built-in active PFC function

Order code	Model number	Output power (W)	Input volts (V AC)	Input Current (mA)	Frequency (Hz)	IP rating	Master case qty
<b>12 V DC</b>							
<b>Hardwired - Dimmable</b>							
65740	LED/DRIVER/50W/12 V/HW/D/STD	50	100-130	410	50/60	IP20	20
<b>Hardwired - Non-dimmable</b>							
65743	LED/DRIVER/10W/12 V/HW/ND/STD	10	100-240	220	50/60	IP65	100
65744	LED/DRIVER/20W/12 V/HW/ND/STD	20	100-240	250	50/60	IP65	100
65745	LED/DRIVER/60W/12 V/HW/ND/VS/STD	60	100-240	1 100	50/60	IP67	30
<b>Plug-in - Non-dimmable</b>							
62265	LED/TAPE/36W/12 V/WW+CW/PS/ND/STD	36	100-240	-	50/60	-	20
62266	LED/TAPE/36W/12V/RGB/PS/ND/STD	36	100-240	-	50/60	-	50
<b>24 V DC</b>							
<b>Hardwired - Dimmable</b>							
65741	LED/DRIVER/50W/24 V/HW/D/STD	50	100-130	410	50/60	IP20	20
65742	LED/DRIVER/96W/24 V/HW/D/STD	96	100-130	800	50/60	IP66	10
<b>Plug-in - Non-dimmable</b>							
65750	LED/DRIVER/60W/24 V/PLUG/ND/STD	60	100-240	1 500	50/60	IP20	36
69554	LED/DRIVER/36W/24V/PLUG/ND	36	100-240	1 000	50/60	IP20	50

### COMPATIBLE DIMMERS<sup>1</sup>

Brand	Model number
COOPER	DAL06P, AAL06, SLC03P
LEVITON	IPL06, 6674, DSL06-1LZ, DSM10-1LZ
LUTRON	PD-6WCL, DVCL-153P, CTCL-153P, DVCL-253P, AYCL-253P, MACL-153P
LEGRAND	HCL453P

Dimming range: 10%-100%

<sup>1</sup> This table shows dimmers that have been tested and have demonstrated proper operation under normal conditions. Each installation being unique, various factors such as load, common neutrals or other electrical products on the circuit can, in certain instances, cause variance in system performance. Read and comply to the dimmer installation instructions. Consult dimming system manufacturer for additional support in operation. Some dimmers may require more than one product for stable operation. Stanpro recommends to use dimmers designed to work with LED products. Older dimmers designed for incandescent products may cause erratic operation.



# 5-IN-1 DIMMABLE

## LED DRIVERS 24 V DC

### HIGH POWER | CLASS 2

Stanpro's commercial grade 5-IN-1 dimmable LED drivers support multiple dimming options in a single unit, providing compatibility with various controls and simplifying installation. Includes both forward and reverse phase: **TRIAC / ELV / MLV, 0-10V, 1-10V, Potentiometer, 10V PWM**. Rated for wet and dry locations.

- High efficiency up to 92%
- AC input: 110-277 V AC
- PWM output & Voltage Reduction (VR) mode
- Flicker-free
- Dimming Range: 0-100%
- Protections: short circuit, over load and temp

#### PWM & VOLTAGE REDUCTION MODES BY DIP SWITCH

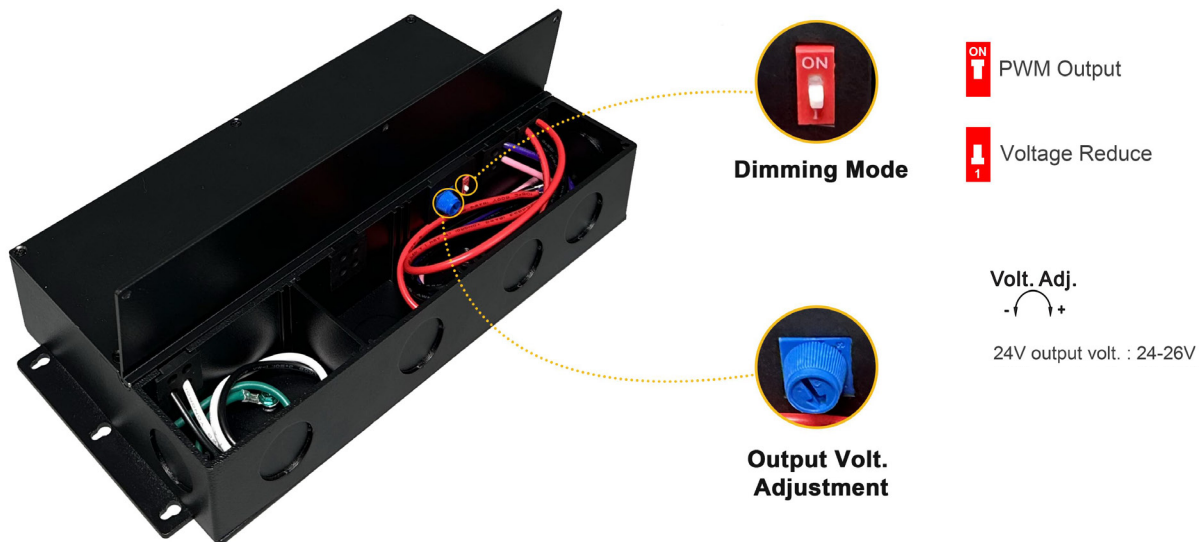

Order code	Model number		Output Volts (V DC)	Watts (W)	Volts (V AC)	Input Current (mA)	Frequency (Hz)	Power factor	Efficiency	Operating Temperature Range	Warranty (yrs)	Master case qty
69132	LED/DRIVER/192W/24V/HW/D	KVE-C24192-TMWJ1-BA	24	192 (2 x 96 W)	100-277	2 200	47/63	≥0.95	92.3 %	-40 °C to 60 °C	5	10
69133	LED/DRIVER/288W/24V/HW/D	KVE-C24288-TMWJ1-BA	24	288 (3 x 96 W)	110-277	3 100	47/63	≥0.95	92.5 %	-40 °C to 60 °C	5	10

## COMPATIBLE DIMMERS<sup>1</sup>

### 0-10 V DIMMING

Brand	Model number	Dimming Range
Lutron	DVSTV-WH	4.5 - 100 %
	DVTV-WH	8 - 100 %

### TRIAC DIMMING

Brand	Model number	Dimming Range	Volts (V AC)
Lutron	SCL-153PR-WH, DVCL-153PR-WH, DVWCL-153PH-LA, CTCL-153PDH-LA, TGCL-153PR-WH, TGCL-153PH-WH, CT-600PR-IV, CT-600PR-WH, CT-103PR-WH, DV-600PR-BL, DV-600PR-WH, TG-600PR-LA, TG-600PR-IV, TG-600PR-WH, TG-10PR-WH, S-600PR-WH, MRF2-6ND-120-AL, MSCELV-600M, MEF2-6ELV-120	0 - 100 %	100-130 V
	MACL-153MH-LA, MIR-600M, MRF2-6CL-GR, PD-6WCL, SELV-300P, DVELV-300P	1-100 %	100-130 V
	DZ6HD	3-100 %	100-130 V
	NTLV-600-277-WH, NTF-10-277	0 - 100 %	277 V
	ST-12P-277	3-100 %	277 V
Leviton	IPL06, 6602, 6683, AWSMT-EAW, AWSMT-EAW	0-100 %	120 V
	VPI06-1LZ, TTI06-1LZ, DZ6HD, 6674, 6672, TBL03	1-100 %	120 V
Legrand	WSCL450TCCCV4, LSCL453PLACCV4	0-100 %	120 V
	RHCL453PNICCV6	1-100 %	120 V
Crestron	CLW-DELVEV-P-W-S	0-100 %	120 V

<sup>1</sup> This table shows dimmers that have been tested and have demonstrated proper operation under normal conditions. Each installation being unique, various factors such as load, common neutrals or other electrical products on the circuit can, in certain instances, cause variance in system performance. Read and comply to the dimmer installation instructions. Consult dimming system manufacturer for additional support in operation. Some dimmers may require more than one product for stable operation. Stanpro recommends to use dimmers designed to work with LED products. Older dimmers designed for incandescent products may cause erratic operation.





