

WARNINGS



RISK OF FIRE, ELECTRICAL SHOCK, CUTS OR OTHER CASUALTY HAZARDS

Installation and maintenance of this product must be performed by a qualified electrician. This product must be installed in accordance with the applicable installation code by a person familiar with the construction and operation of the product and hazards involved.

RISK OF FIRE AND ELECTRIC SHOCK

Make certain power is OFF before starting installation or attempting any maintenance. Disconnect power at fuse or circuit breaker.

RISK OF FIRE

Refer to product label for specific minimum supply conductor requirements.

RISK OF BURN

Disconnect power and allow fixture to cool before handling or servicing.

RISK OF PERSONAL INJURY

Fixture may become damaged and/or unstable if not installed properly.

DISCLAIMER OF LIABILITY: CSC LED assumes no liability for damages or losses of any kind that may arise from the improper, careless, or negligent installation, handling or use of this product.

NOTICE: Green ground wire is provided in proper location. Do not relocate.

SAFETY: This fixture must be wired in accordance with the National Electrical Code and applicable local codes and ordinances. Proper grounding is required to ensure personal safety. Carefully observe grounding procedure under installation section.

APPLICATIONS: This lighting fixture is designed for indoor lighting applications, and should not be used in an area with limited ventilation or inside high ambient temperature enclosures. It must be stored in a dry location prior to installation.

MAINTENANCE: The luminaire needs to be powered off and must be cool to the touch before maintenance. Clean the lens with a non-abrasive glass cleaning solution. Use a wet or dry cloth to wipe the lens and the debris from the luminaire body. Arrange maintenance according to the level of debris accumulation.

ATTENTION RECEIVING DEPARTMENT: Note actual fixture description of any shortage or noticeable damage on delivery receipt. File claim for common carrier (LTL) directly with carrier. Claims for concealed damage must be filed within 15 days of delivery. All damaged material, complete with original packaging must be retained.

POWER, CCT, & DISTRIBUTION SWITCHES

1. Power, CCT, and distribution can be set by the switches located on the back of the fixture.

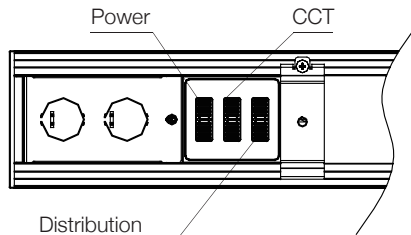

SWITCH	DEFAULT SETTING
Power: 2': 15W/20W/25W 4': 30W/40W/50W 8': 60W/80W/100W	Max Wattage
CCT: 27K/30K/35K/40K/50K	4000K
Distribution: 0% uplight / 100% downlight 10% uplight / 90% downlight 30% uplight / 70% downlight	0% uplight 100% downlight

POWER & WIRING DIAGRAM

VOLTAGE	MAX WATTAGE CONNECTION
120V	400W
347V	1250W

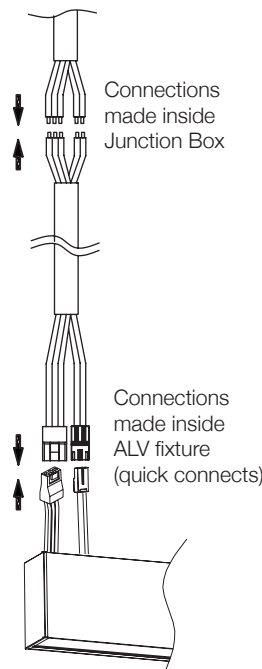
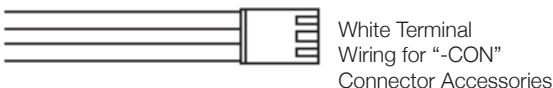
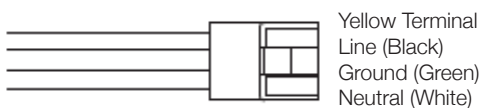

1. Power Cord is purchased separately and required for use.

2. Make wiring connections according to the wiring diagram. If dimming wires aren't being used, separate and cover with wire nuts or lever connectors.

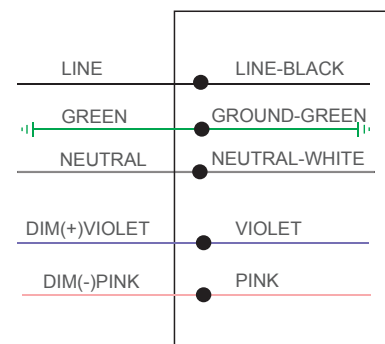

SUSPENDED MOUNT

CANOPY / DRYWALL

ALV LENGTH	SUGGESTED HOLE DISTANCE
2'	400mm / 15.75"
4'	800mm / 31.50"
8'	2000mm / 78.75"

Fig. 1

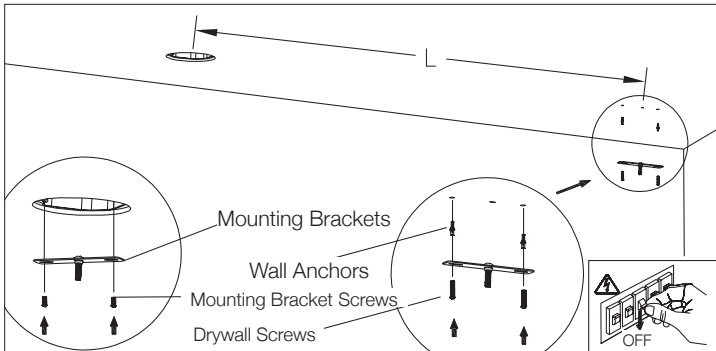

Fig. 2

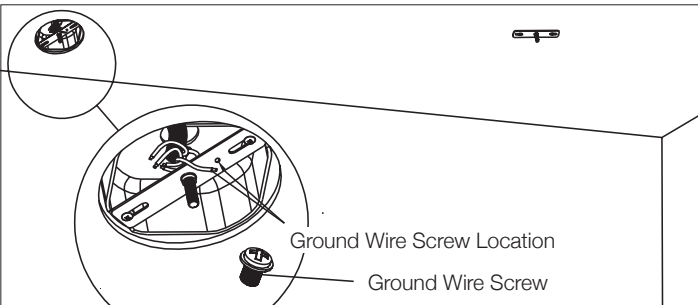

Fig. 3

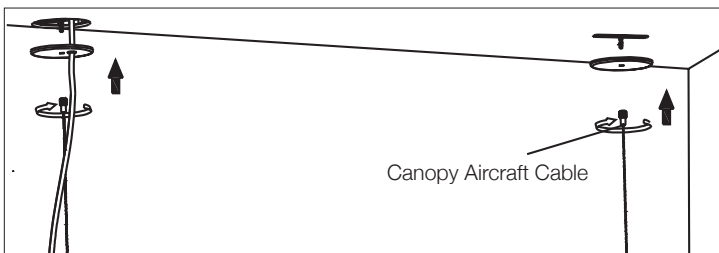

Fig. 4

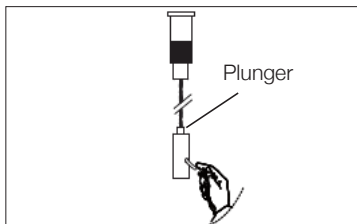

Fig. 5

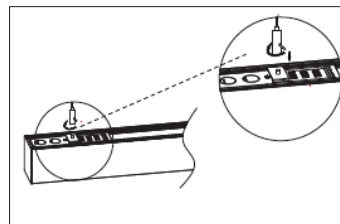

Fig. 6

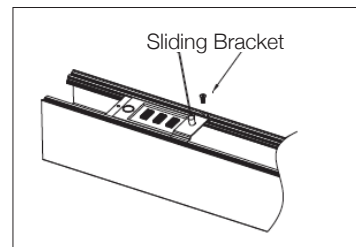
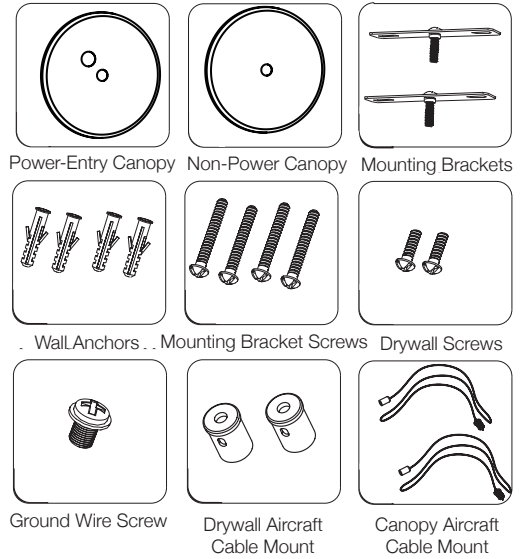

Fig. 7

PARTS LIST



1. Determine mounting locations using the table in Fig. 1.

2. Connect mounting brackets to junction box using mounting bracket screws, or connecting mounting bracket to drywall using drywall screws (Fig. 2)

3. Insert ground wire screw according to Fig. 2.

4. Connect power cord (sold separately) by feeding cord through power-entry canopy and connecting wires according to the wiring diagram on page 1.

5. Connect canopies to mounting brackets by screwing on the canopy aircraft cables to the male threaded end of the mounting brackets or T-Bar kit (Fig. 4).

6. Adjust aircraft cable to desired length by pressing down on the plunger, or pulling cable to shorten (Fig. 5).

7. Attach the aircraft cables to the ALV fixture by securing them to the pre-installed mounting screws on the sliding brackets located on the back of the fixture (Fig. 6).

8. Adjust the sliding bracket if necessary to evenly disperse weight (Fig. 7).

T-BAR

PARTS LIST



NOTE: Suspension Kit is required for T-Bar installation

1. Assemble the T-Bar clips by connecting T-Bar Clip A and T-Bar Clip B together around the T-Bar, using the provided screws (Fig. 1).

2. Connect safety support cable (steel wire) to top of T-Bar mount (top of Fig. 2).

3. Connect power cord and canopy covers according to the Canopy / Drywall instructions (steps 4-8) on page 2.

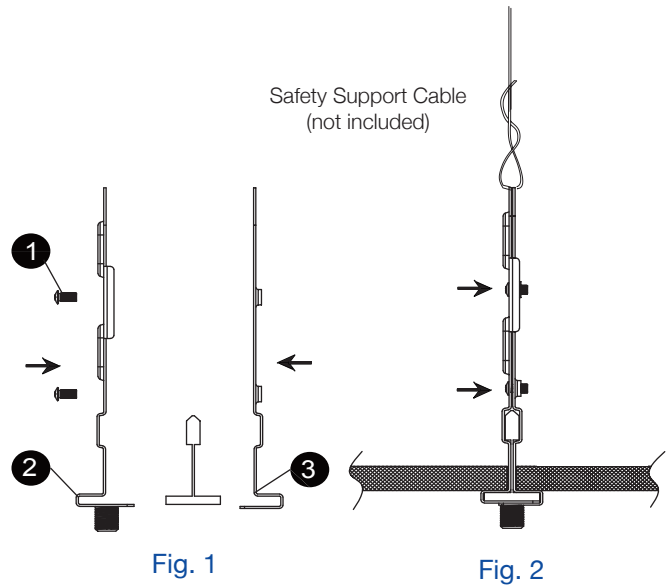

INLINE CONNECTION

1. Remove screw to release the wiring compartment cover and remove screws to release the end cap (Fig. 1).

2. Insert the inline connector into the end of the fixture. Connect the buckle to the buckle connector latch and secure with inline connector screws. Refer to Fig. 2 and Fig. 6.

3. Remove lenses of the two fixtures being connected by sliding them out, and connect the connector brackets using the connector bracket screws. Refer to Fig. 3 and Fig. 4. Reinsert lenses.

4. Connect power (yellow) and dimming (orange) quick connects. Disregard white quick connects (Fig. 7).

5. Reattach the wiring compartment cover.

PARTS LIST

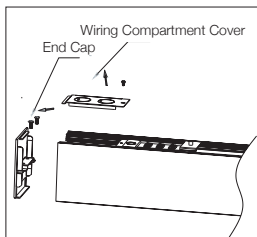
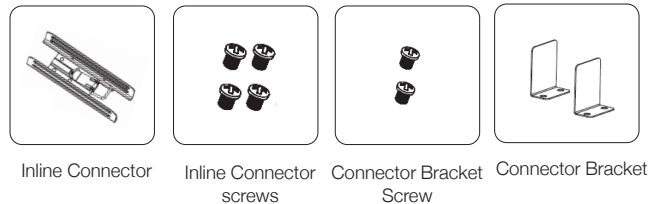

Fig. 1

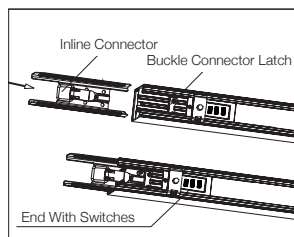

Fig. 2

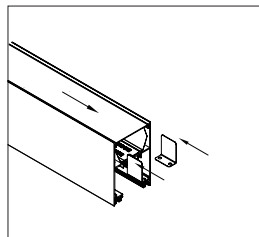

Fig. 3

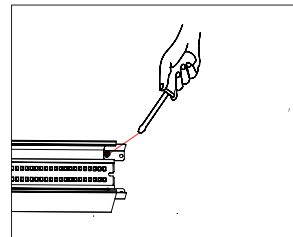

Fig. 4

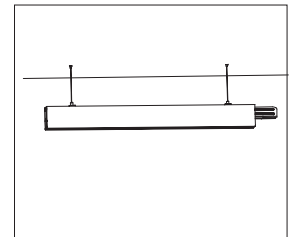

Fig. 5

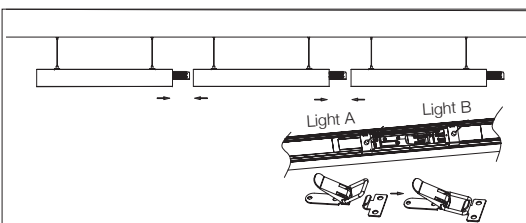

Fig. 6

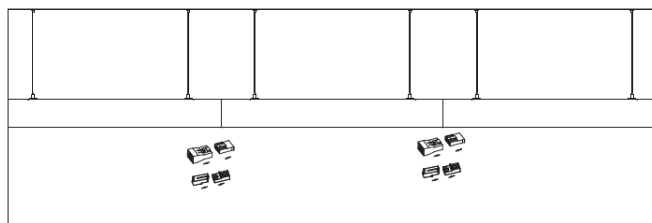

Fig. 7

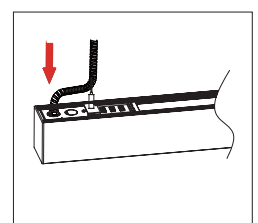

Fig. 8

SURFACE MOUNT

1. Insert power cord through square junction box cover and make wiring connections, refer to page 1. Connect square junction box cover plate to junction box using short screws (Fig. 1).
2. Attach surface mount brackets to back of fixture using short screws (Fig. 2).
3. Use suggested hole distances (Fig. 8) and mark them on the surface (Fig. 3).
4. Insert wall anchors (Fig. 4).
5. Make wiring connections (Fig. 5), refer to wiring diagram on page 1.
6. Mount fixture using the provided long screws (Fig. 6).

PARTS LIST

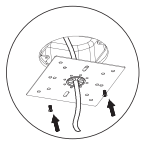
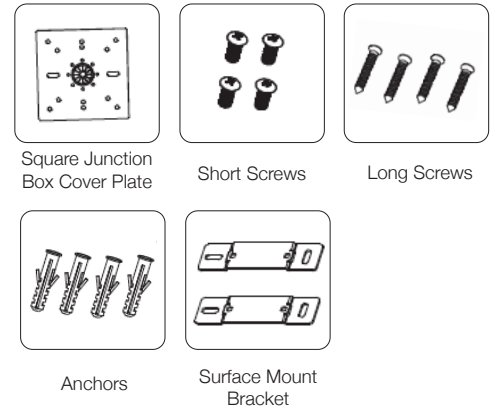

Fig. 1

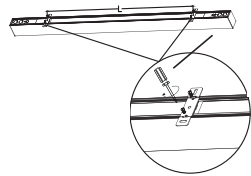

Fig. 2

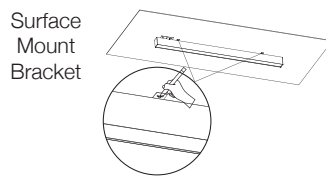

Fig. 3

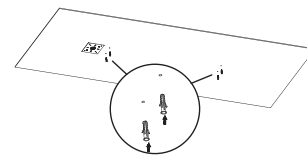

Fig. 4

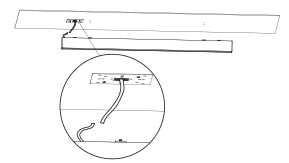

Fig. 5

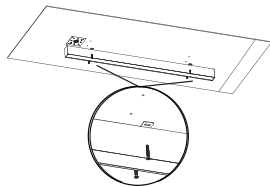

Fig. 6

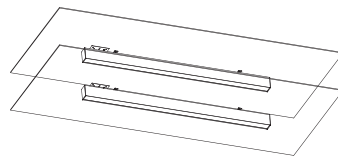

Fig. 7

ALV LENGTH	SUGGESTED HOLE DISTANCE
2'	400mm / 15.75"
4'	800mm / 31.50"
8'	2000mm / 78.75"

Fig. 8

RECESSED MOUNT

1. Before installation, ensure the mounting surface is appropriate for this recessed kit. The kit is designed for surfaces with a thickness of 3-30 mm. If there is any uncertainty about the strength or stability of the mounting surface, we recommend using a safety support cable as a precaution (Fig. 1).
2. Based on fixture size, measure and cut opening according to the dimensions in Fig. 2. If row mounting multiple fixtures, refer to product dimensions provided on the product sheet. Recessed mounting kit not compatible with shape connectors. Linear in-line runs only.
3. Affix the recessed mounting kit support brackets to the frame using the provided screws. Remove the screw hole covers from the recessed mounting kit (Fig. 3).
4. Place recessed mounting kit around ALV fixture and insert recessed mounting kit end frame pieces (Fig. 4). For row mounting multiple luminaires, see in-line connection instructions.
5. Connect recessed mounting kit to ALV fixture using the provided screws. Screws that are inserted into the support brackets are screwed into the side channels on the back of the fixture (Fig. 5).
6. Make wiring connections (Fig. 6) using the power cord (ordered separately), refer to wiring diagram on page 1. Attach safety support cable to support brackets (Fig. 6).
7. Lift recessed mounting kit and fixture into ceiling cavity. While holding it in place, use a screwdriver to turn the screws (previously hidden behind the screw hole covers). As you turn the screws, the support arms will extend and lock into position above the ceiling. Continue tightening until the kit is securely clamped in place (Fig. 7).
8. Re-insert screw hole covers (Fig. 8).

PARTS LIST



Screws

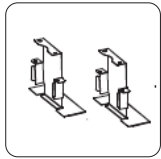

Recessed Mounting Kit End Frame

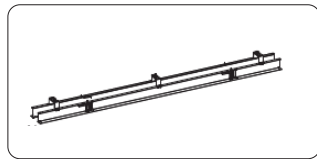

Recessed Mounting Kit Side Frame

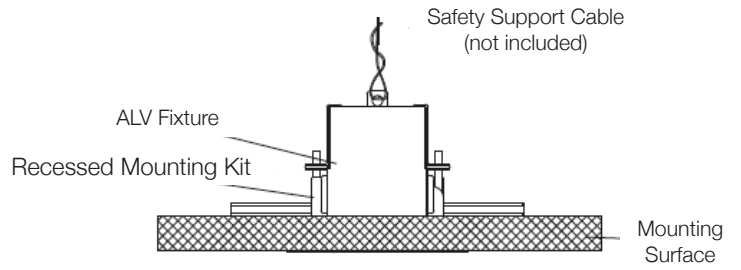
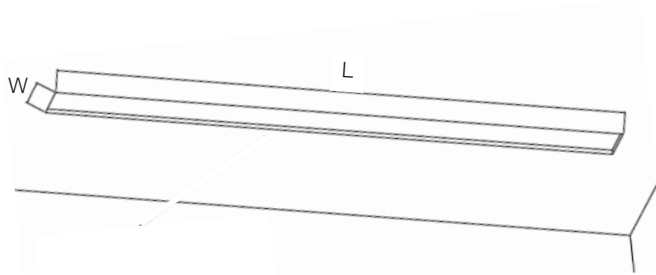

Fig. 1

RECESSED OPENING DIMENSIONS			
	2'	4'	8'
L	620mm/24.41"	1230mm/48.43"	2450mm/96.46"
W	102mm / 4.0"		

Fig. 2

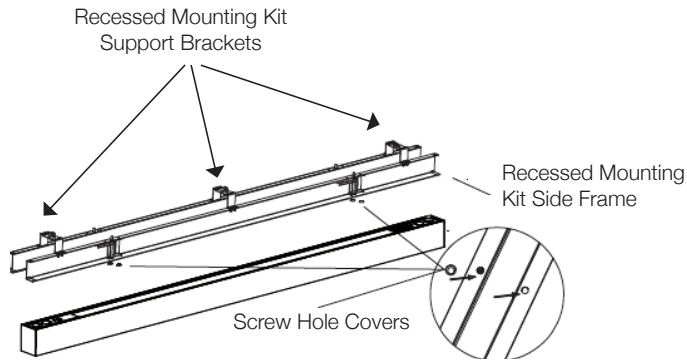

Fig. 3

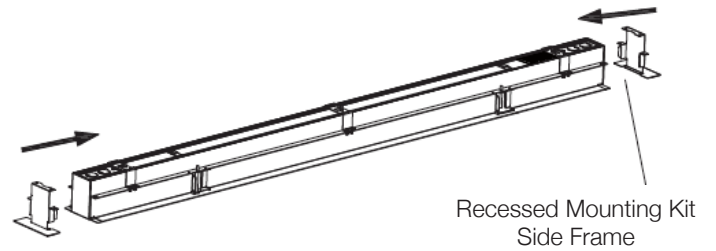

Fig. 4

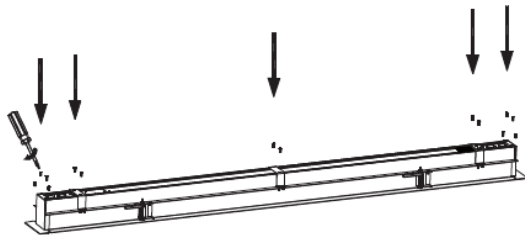

Fig. 5

For multiple luminaires, see inline connection instructions

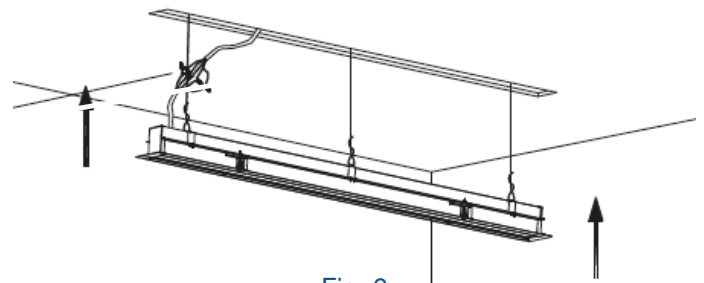

Fig. 6

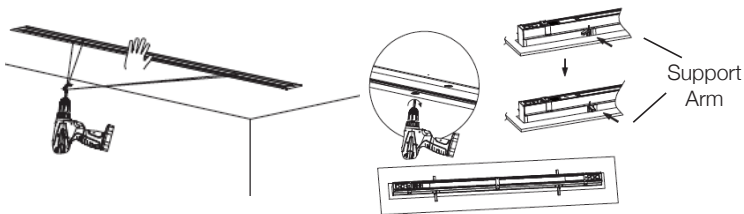

Fig. 7

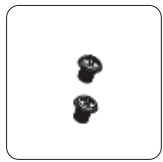

Fig. 8

WALL MOUNT

1. Insert power cord through square junction box cover, make wiring connections inside junction box (refer to page 1) and connect square junction box cover to junction box (Fig. 1). Mark a straight and level line on the wall (Fig. 2).
2. Mark mounting holes using the wall mount bracket as a template, and use the suggest mounting hole distances in Fig. 2.
3. Affix wall mount brackets to the wall using the provided screws and anchors (Fig. 3).
4. Line up the sliding mounting bracket located on the back of the fixture with the wall mount brackets and use provided 6-lobed nuts to secure (Fig. 4).
5. Make wiring connections inside of the ALV fixture using the quick connects (Fig. 5), refer to page 1 wiring diagram.

PARTS LIST



Junction Box Plate
Screws



Wall Mount Bracket
Screws



Anchors

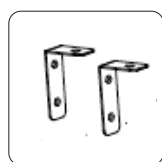

Wall Mount Brackets



6-Lobed Nuts



Strain Relief

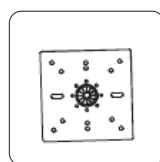

Square Junction
Box Cover

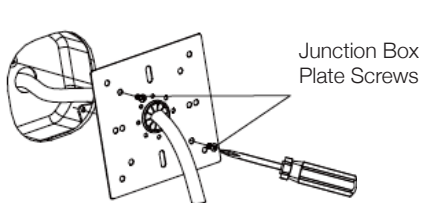

Fig. 1

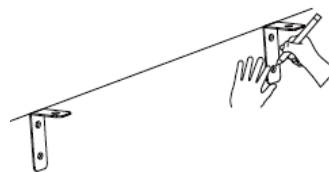

Fig. 2

ALV LENGTH	SUGGESTED HOLE DISTANCE
2'	400mm / 15.75"
4'	800mm / 31.50"
8'	2000mm / 78.75"

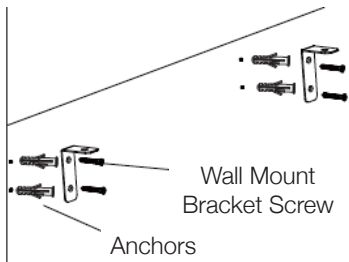

Fig. 3

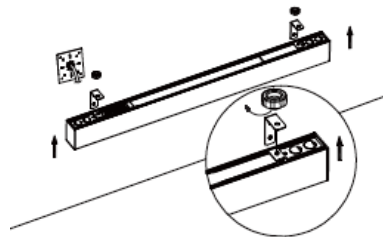

Fig. 4

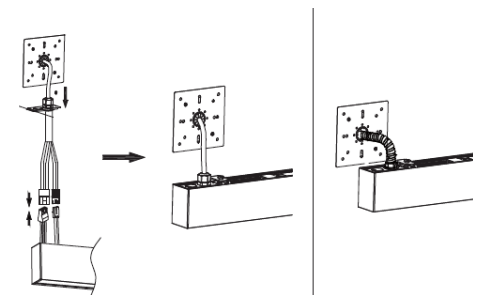
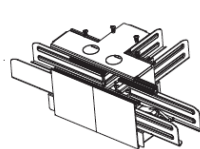

Fig. 5

CONNECTOR CONFIGURATIONS

VOLTAGE	MAX WATTAGE CONNECTION
120V	400W
347V	1250W

CONNECTORS



T

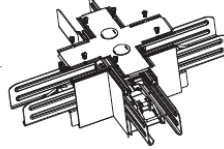

X

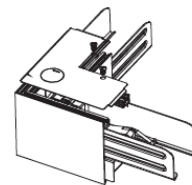

L

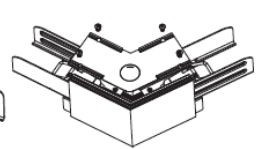

V

INLINE SHAPE (L & V) CONNECTION INSTRUCTIONS

1. Remove screw to release the wiring compartment cover and remove screws to release the end caps (Fig. 1).
2. Remove wiring compartment cover and insert the ALV fixture into each end of the inline shape connector. Lock by securing buckle latch (Fig. 2).
3. Make all wiring connections with quick connects (Fig. 3).
4. Reattach wiring compartment cover.

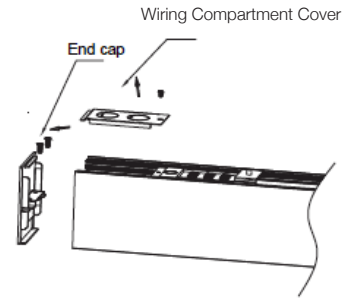

Fig. 1

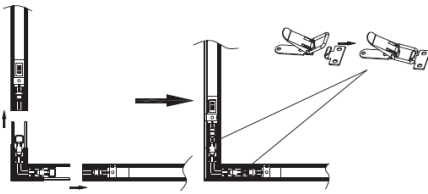
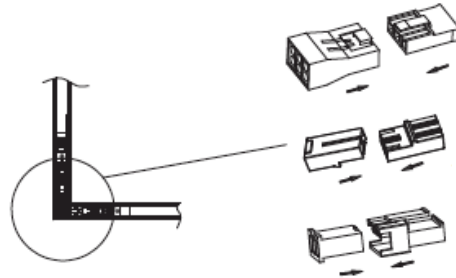

Fig. 2



- 3 Position Quick Connectors (Yellow): Black (LINE)
White (NEUTRAL)
Green (GROUND)
- 2 Position Quick Connectors (Orange): Purple (DIM+)
Pink (DIM-)
- 3 Position Quick Connectors (White): Wiring for -CON
connector accessories

Fig. 3

INTERSECTION SHAPE (T & X) CONNECTION INSTRUCTIONS

1. Remove screw to release the wiring compartment cover and remove screws to release the end caps (Fig. 1).
2. Remove wiring compartment cover of T/X shape connectors and insert the ALV fixture into each end of the end of the intersection shape connector. Lock by securing buckle latch and connect the white quick connects (Fig. 2).
3. Connect the multi-connector harness's ground wire to the T or X shape connector (Fig. 3).
4. Connect all power and dimming quick connects (Fig. 4 and 5). One fixture must be receiving power from the power cord (sold separately).
5. Reattach wiring compartment cover.

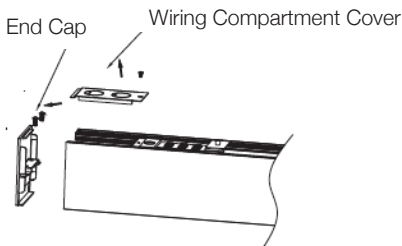

Fig. 1

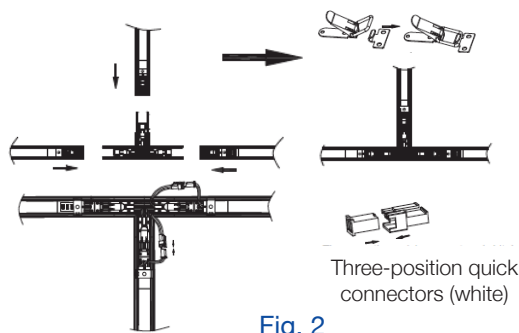

Fig. 2

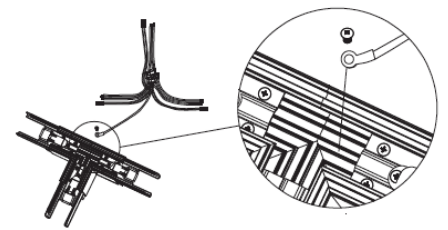

Fig. 3

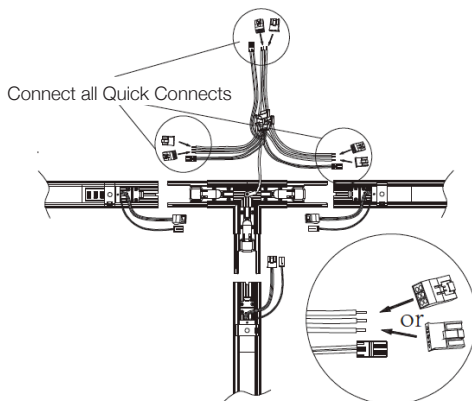

Fig. 4

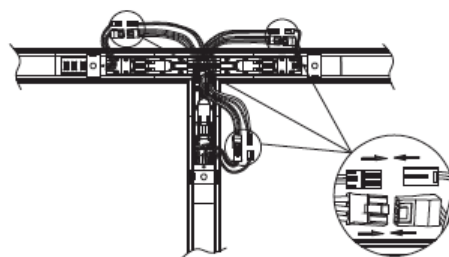

Fig. 5

- Orange Terminal
DIM+ (Violet)
DIM- (Pink)
- Yellow Terminal
Line (Black)
Ground (Green)
Neutral (White)
- White Terminal
Wiring for "-CON"
Connector Accessories